

filo 55s_

stipite telescopico - telescopic jamb

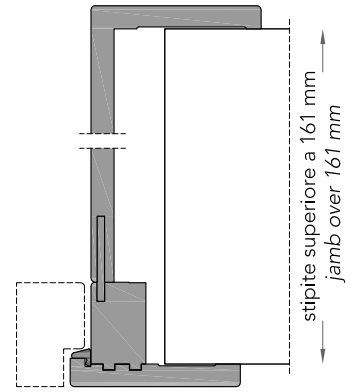
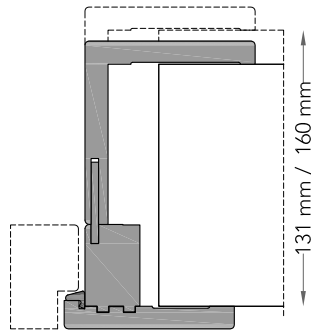
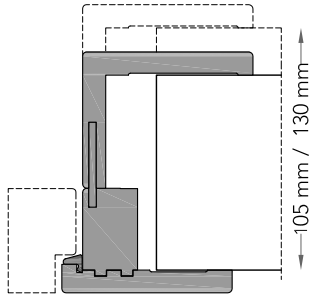

cartongesso - drywall

muratura - brickwall

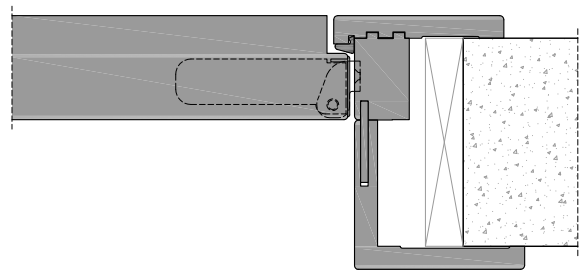
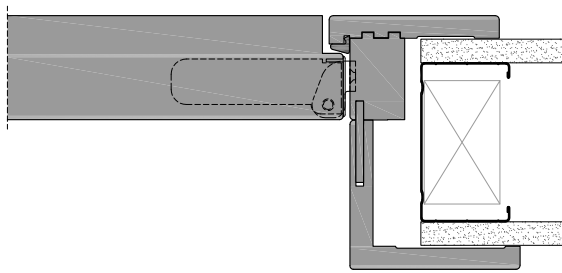

spingere destra - push right

spingere sinistra - push left

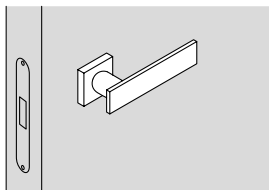
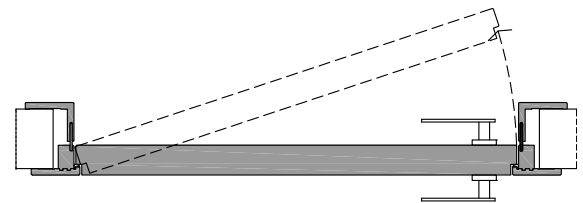
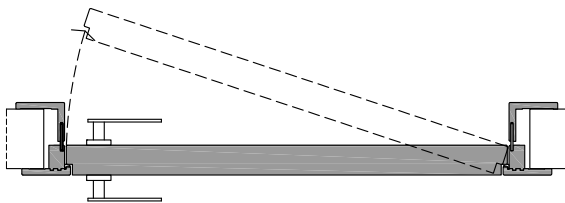

solo maniglia
only passage

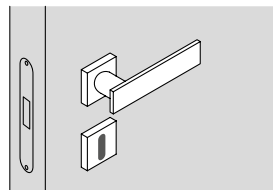

maniglia e chiave
handle and key

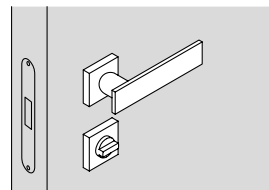

maniglia e nottolino
handle and privacy

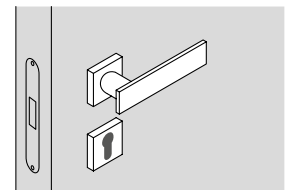

maniglia e cilindro di sicurezza
handle and security cylinder

filo 55t_

sezione verticale - vertical section

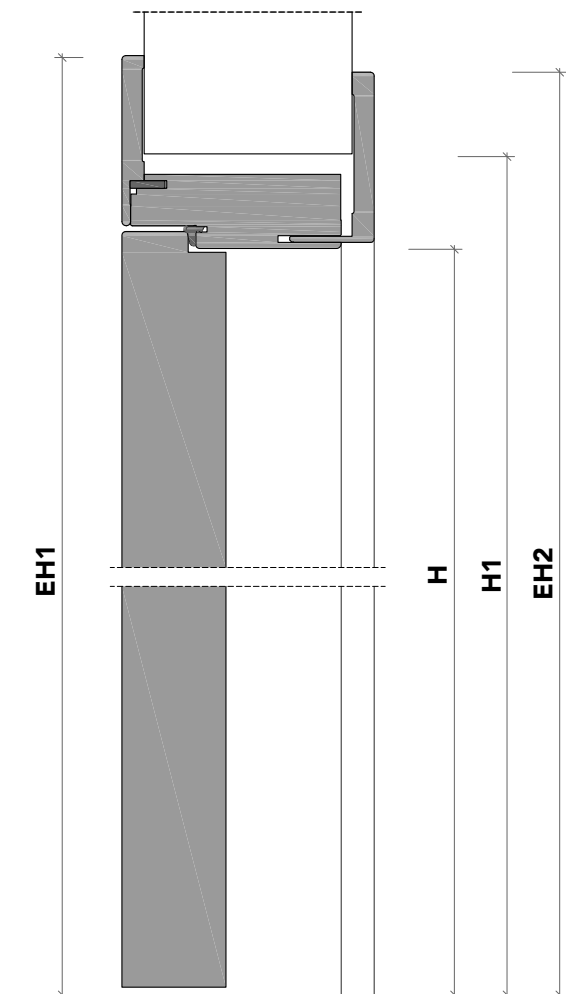

misure nette
net opening

L	=	luce / width
H	=	altezza / height

vano muro
rough opening

L1	=	L + 100 mm
H1	=	H + 50 mm

ingombro totale
overall sizes

EL1	=	L + 203 mm
EH1	=	H + 101 mm
EL2	=	L + 185 mm
EH2	=	H + 92 mm

sezione orizzontale - horizontal section

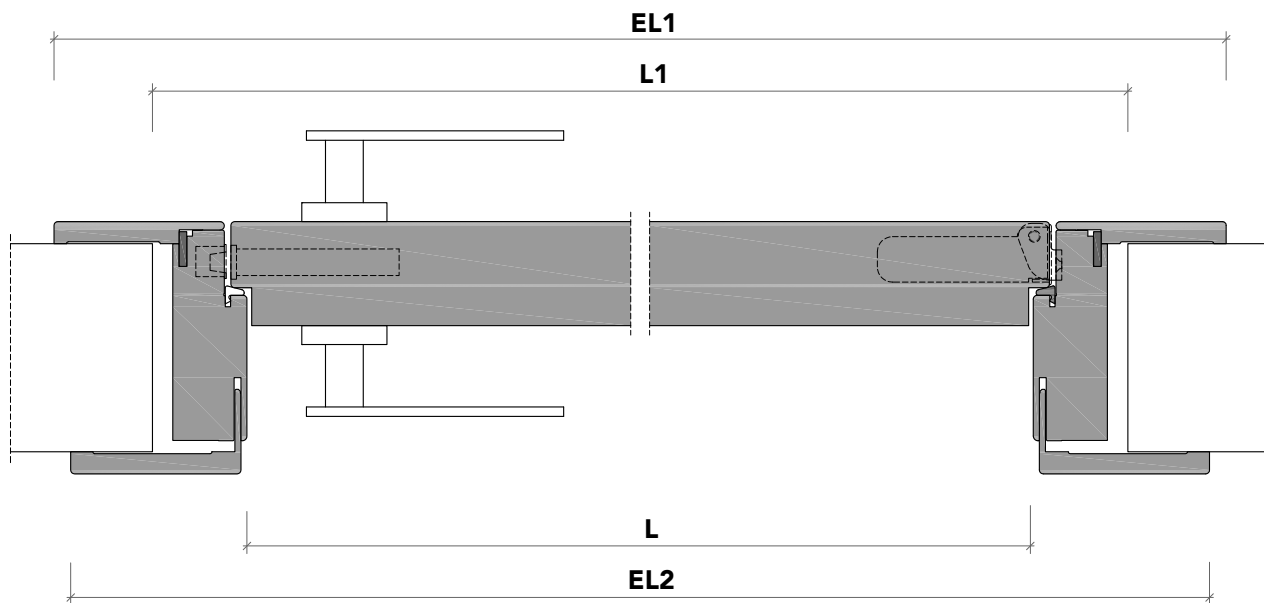

filo 55t_

stipite telescopico - *telescopic jamb*

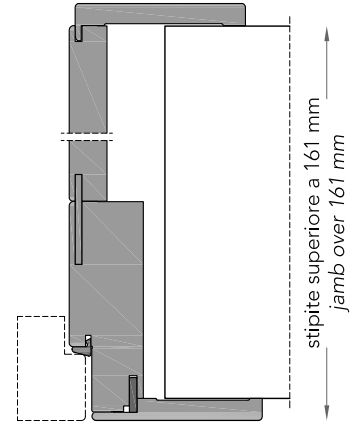
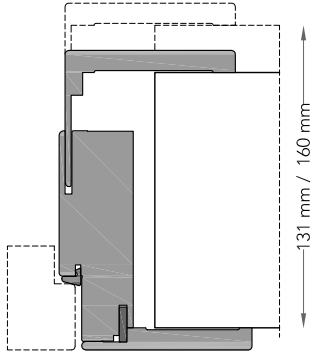
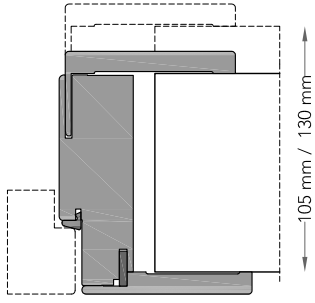

cartongesso - *drywall*

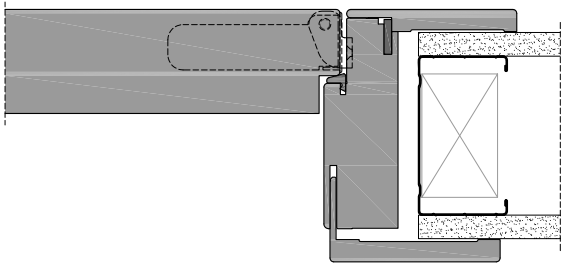

muratura - *brickwall*

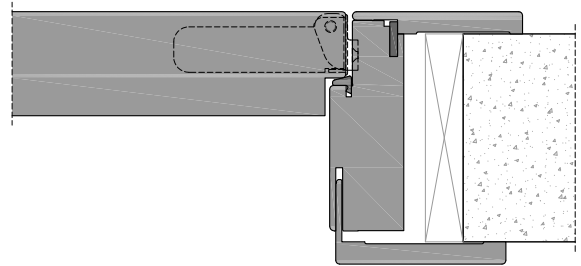

spingere destra - *push right*

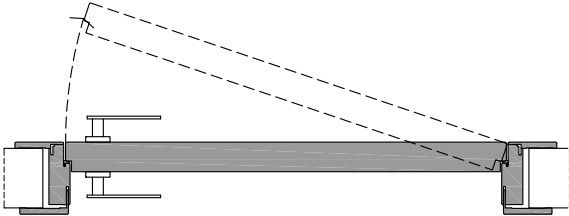

spingere sinistra - *push left*

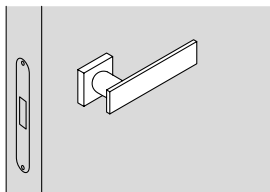
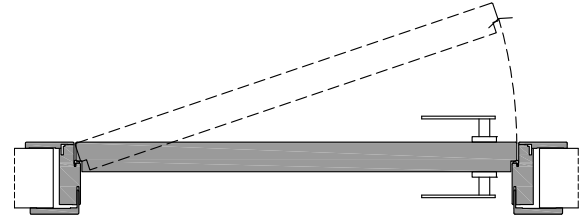

solo maniglia
only passage

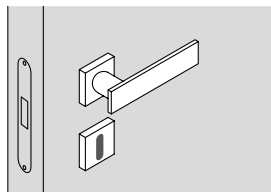

maniglia e chiave
handle and key

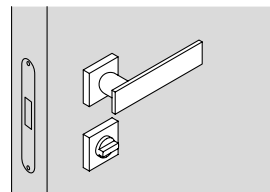

maniglia e nottolino
handle and privacy

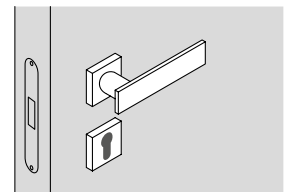

maniglia e cilindro di sicurezza
handle and security cylinder

scorrevole a scomparsa / pocket door

lcd62_ filo 55_ san siro_

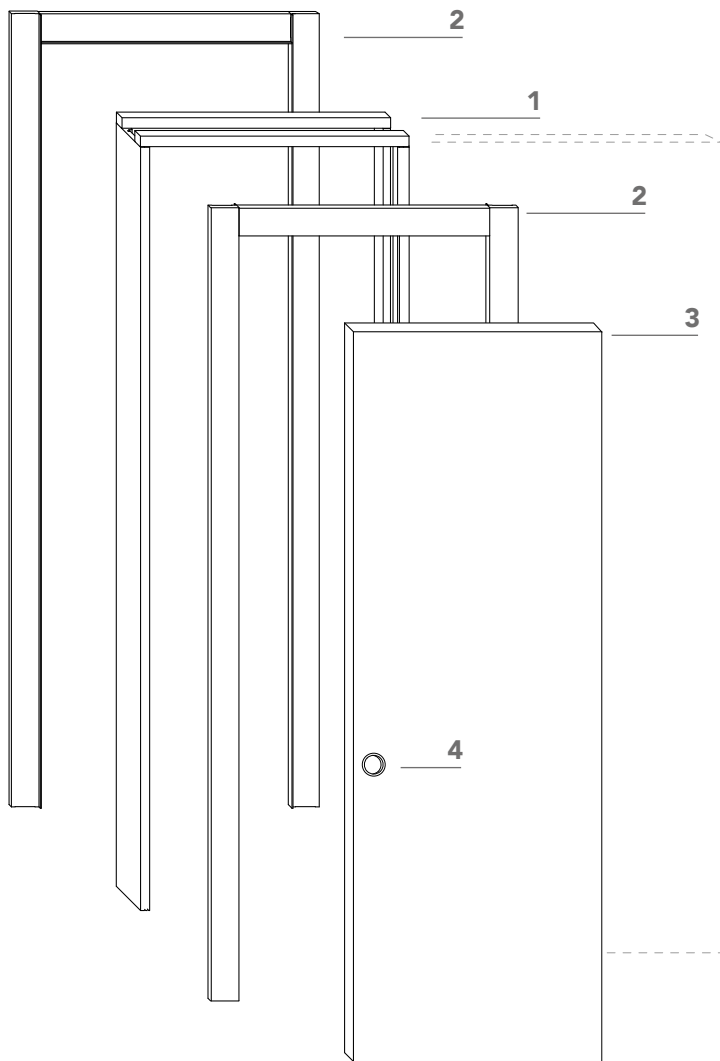

1 stipite in legno;
wood jamb;

2 coprifilo di spessore 12 mm;
trim 12 mm thickness;

3 anta di spessore 41 mm in legno con
struttura tamburata. Completa di
maniglia ad incasso (**4**) e guarnizione di
battuta antirumore;

*wood sliding pocket door 41 mm
thickness. Hardware included: flush
handle (**4**), anti-noise gasket;*

4 maniglia ad incasso.
flush handle.

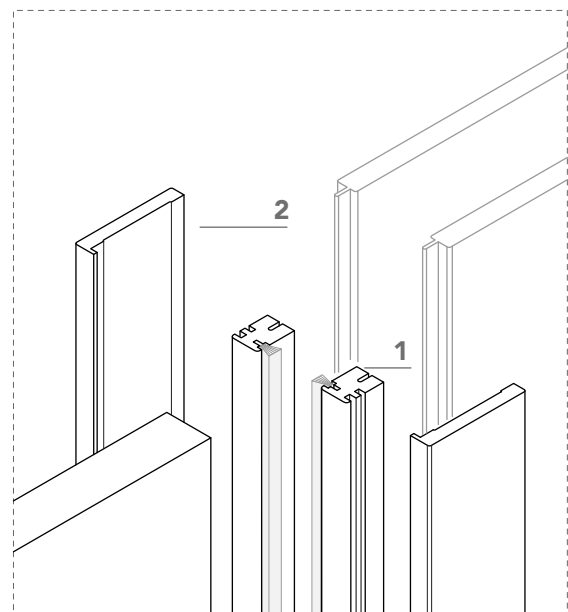
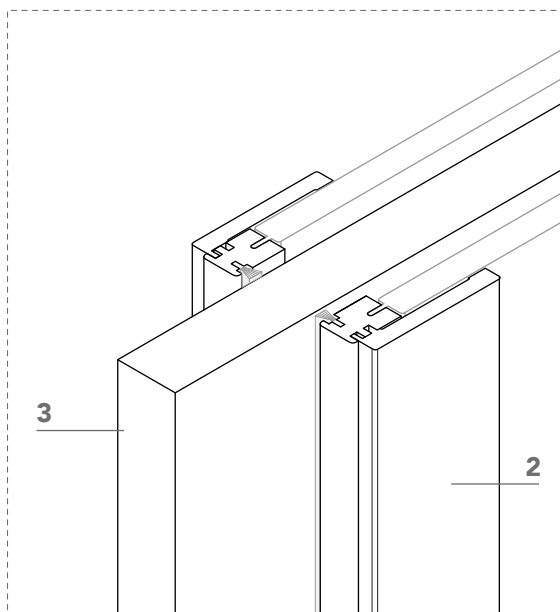

scorrevole a scomparsa / pocket door

lcd62_ filo 55_ san siro_

sezione verticale - vertical section

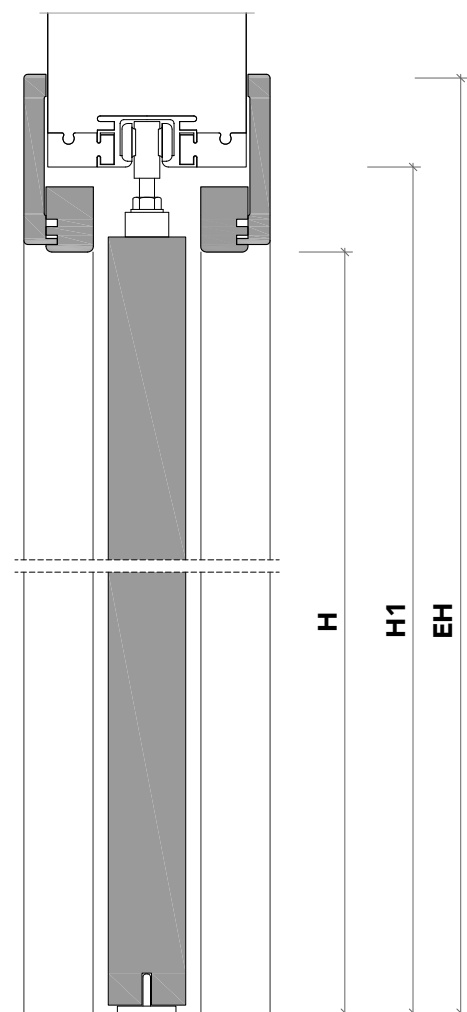

misure nette
net opening

L	=	luce / width
H	=	altezza / height

controtelaio
rough opening

L1	=	L + 45 mm
H1	=	H + 45 mm

controtelaio
rough sizes

A	=	spessore parete wall thickness
B	=	intercapedine interspace

ingombro totale
overall sizes

EL	=	L + 168 mm
EH	=	H + 94 mm

sezione orizzontale - horizontal section

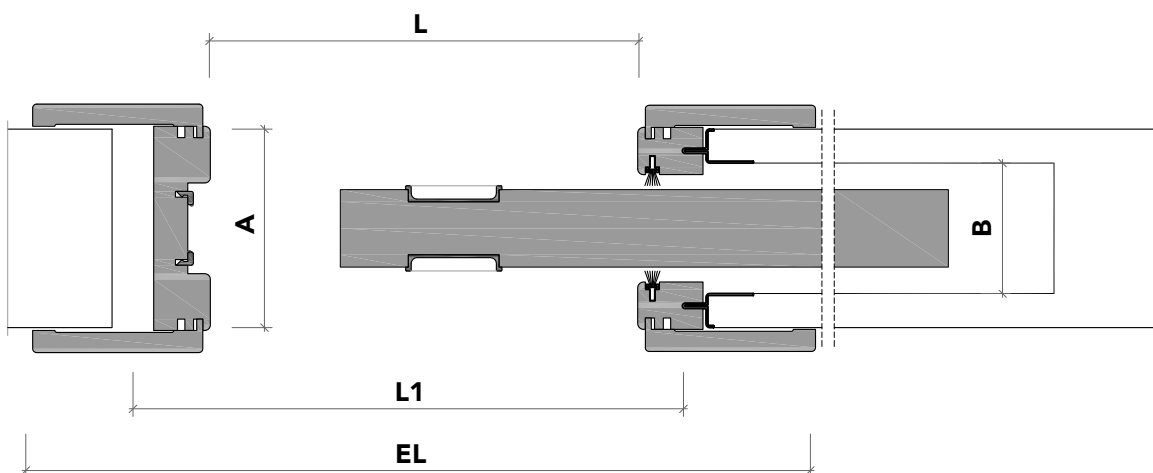

scorrevole a scomparsa / pocket door
lcd62_ filo 55_ san siro_

parete con rivestimento ▪ *cladding wall version*

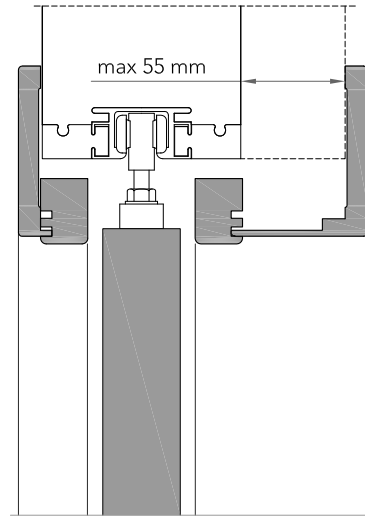
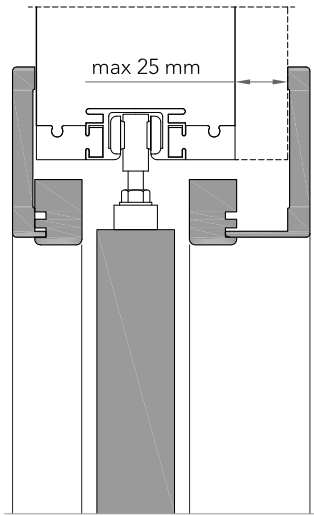

scorrevole sinistra ▪ *sliding left*



scorrevole destra ▪ *sliding right*

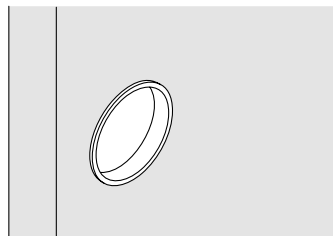

solo maniglia ad incasso
only flush handle

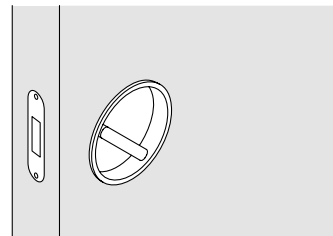

maniglia ad incasso e nottolino
flush handle and privacy