

## Skye\_

Sistema di ante scorrevoli in vetro con profilo e listelli in legno.  
Sliding glass door system with profile and vertical wood slats.

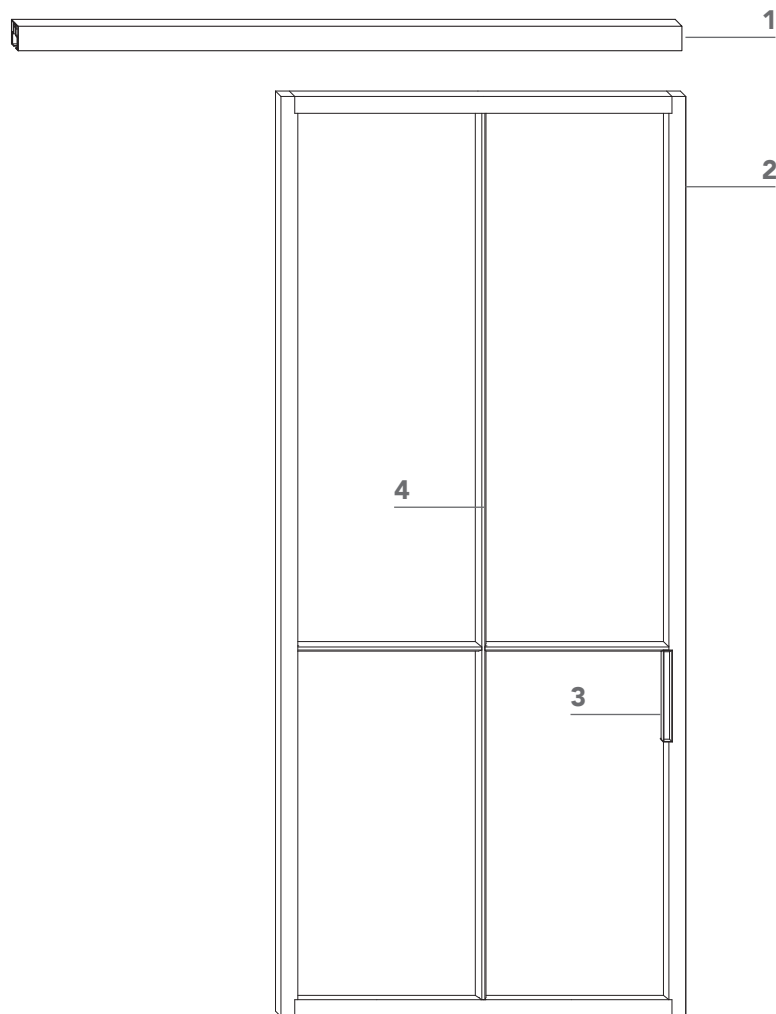

**1** binario con sistema decelerante e carrello con meccanismo di regolazione in altezza;

*rail with shock absorber and sliding trolley with height adjustment mechanism;*

**2** anta di spessore 50 mm, configurabile in diversi sistemi di pannelli scorrevoli e fissi, disponibile con vetro di sicurezza spessore 6 mm e profilo in legno;

*sliding system with aluminum frame 50 mm thick, and tempered glass 6 mm thick. The system is available with fix and sliding panels;*

**3** maniglia compresa;  
*handle included.*

**4** listelli 20x16/10 mm;  
*slats 20x16/10 mm.*

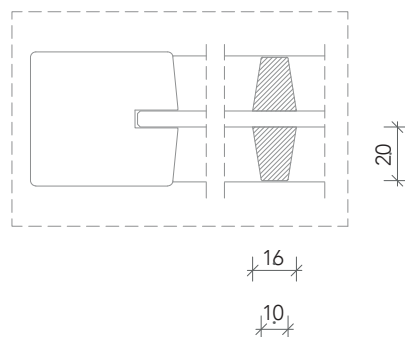

## Finiture - Finishing

### Binario - Rail

alluminio - aluminum

naturale - nero opaco - bianco opaco - bronzo - brill spazzolato - *natural - matte black - matte white - bronze - brushed brill*

### Profilo anta e listelli- Panel profile and slats

essenze - veneer

rovere : naturale - moka - *oak: natural - moka*  
noce canaletto - *canaletto walnut*

### Anta in vetro - Glass panel

vetri base - standard glass

trasparente: extrachiaro - grigio - bronzo - *transparent: extraclear - grey - bronze*  
satinato (un lato) : extrachiaro - grigio - bronzo - *satin (one side): extraclear - grey - bronze*  
extrachiaro opalino - *opaline extraclear*

vetri riflettenti - reflective glass

riflettente (un lato) : extrachiaro - grigio - bronzo - *reflective (one side): extraclear - grey - bronze*

vetri retrolaccati - backpainted glass

bianco gesso - bianco ottico - avorio - grigio calce - grigio tortora - grigio ferro - terra  
*chalk white - pure white - ivory - lime grey - dove grey - iron grey - clay*

vetri con retina - glass with mesh

retina: bronzo - Damier - *mesh: bronze - Damier*

binario ad incasso - recessed rail

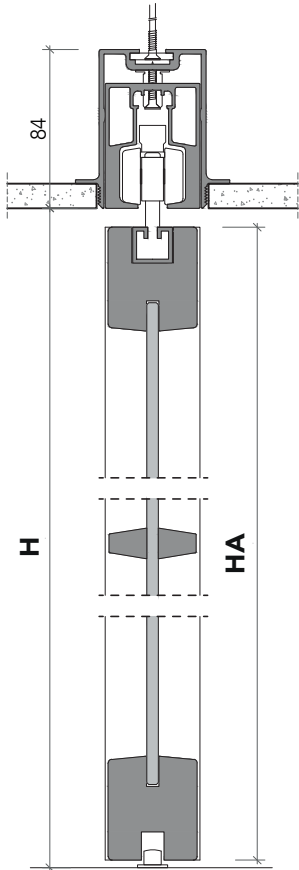

binario esterno - external rail

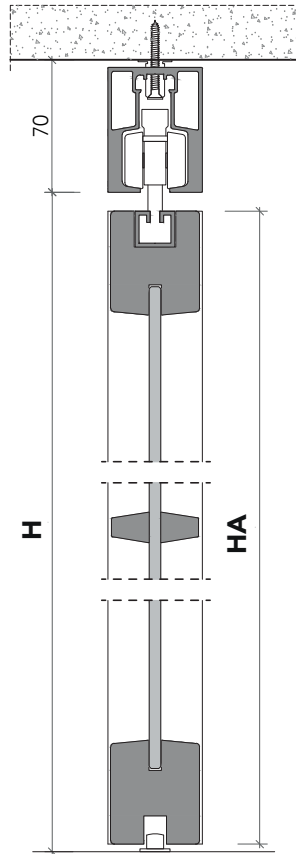

binario a parete - wall rail

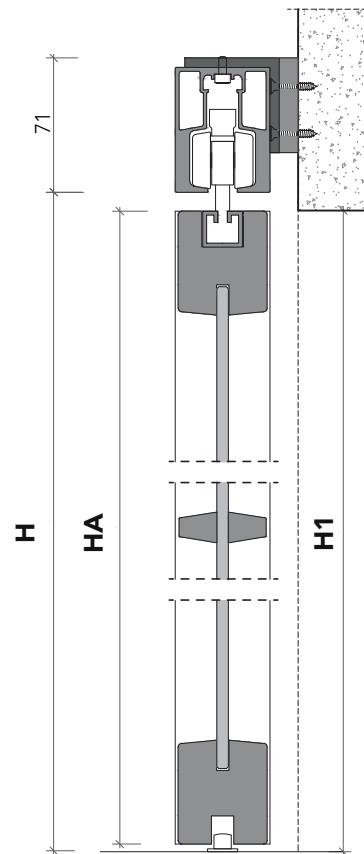

misure nette | **L** = luce / width  
 net opening | **H** = altezza / height

misura anta | **LA** = L + 40 mm  
 panel sizes | **HA** = H - 14 mm

**H1** = H - 10 mm

falso binario subframe

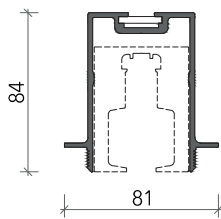

binario singolo single rail

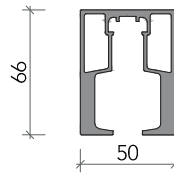

supporto a parete wall fastening

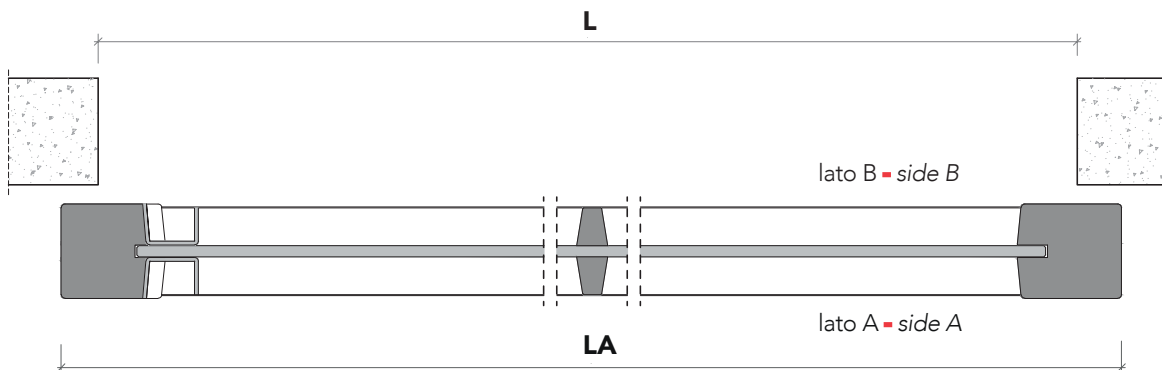
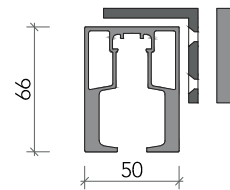

binario ad incasso = recessed rail

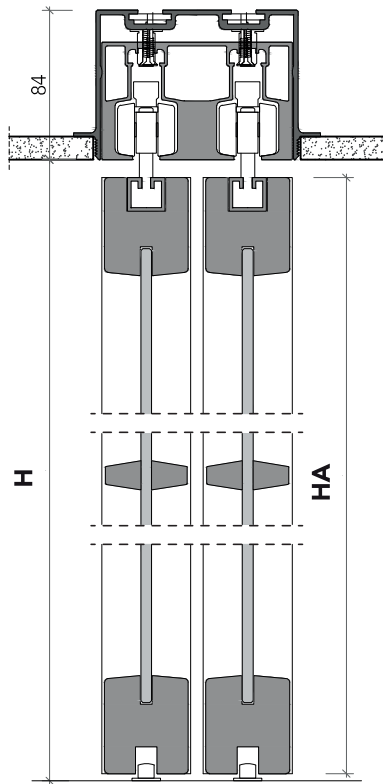

binario esterno = external rail

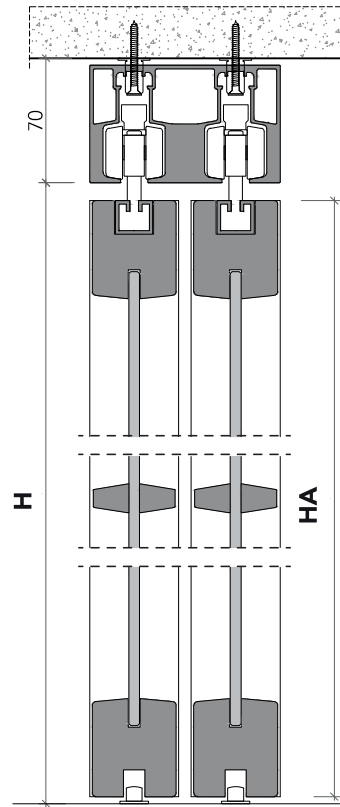

misure nette | **L** = luce / width  
 net opening | **H** = altezza / height

misura anta | **LA** =  $(L + 50 \text{ mm}) / 2$   
 panel sizes | **HA** =  $H - 14 \text{ mm}$

falso binario  
subframe

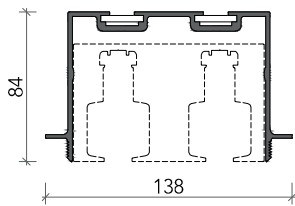

binario doppio  
double rail

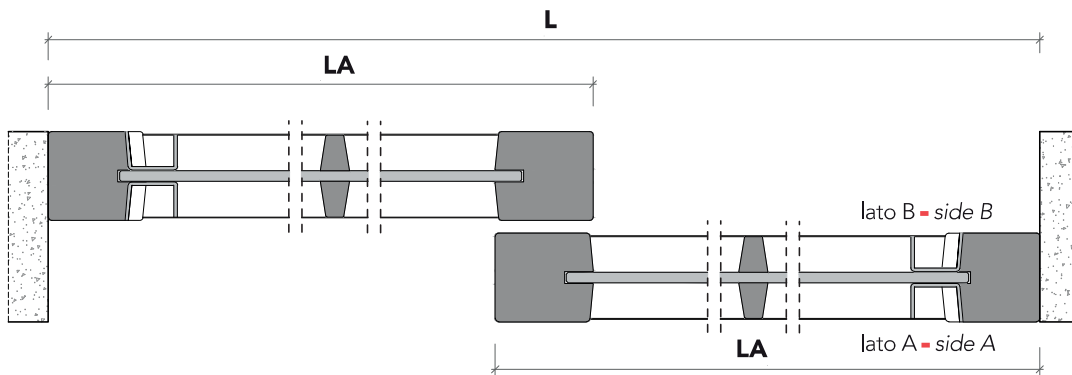
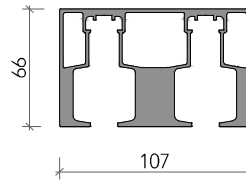

# Sistemi scorrevoli / Sliding system

configurazioni / configuration

anta singola esterno muro  
single panel external

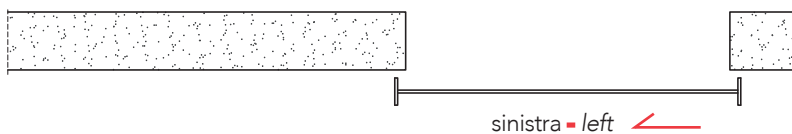
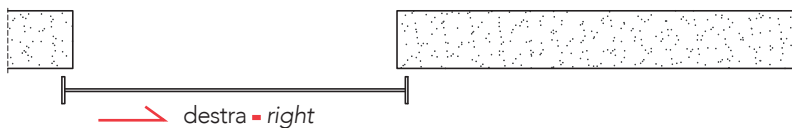

anta doppia esterno muro  
double panel external

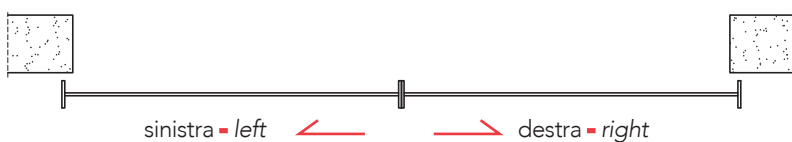

anta doppia in luce  
double panel internal

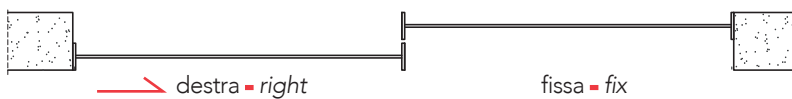
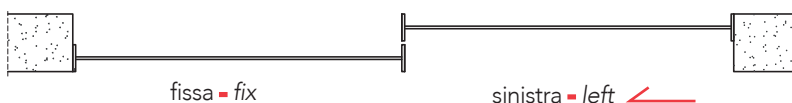

# Sistemi scorrevoli / Sliding system

configurazioni / configuration

tre ante esterno muro  
three panels external

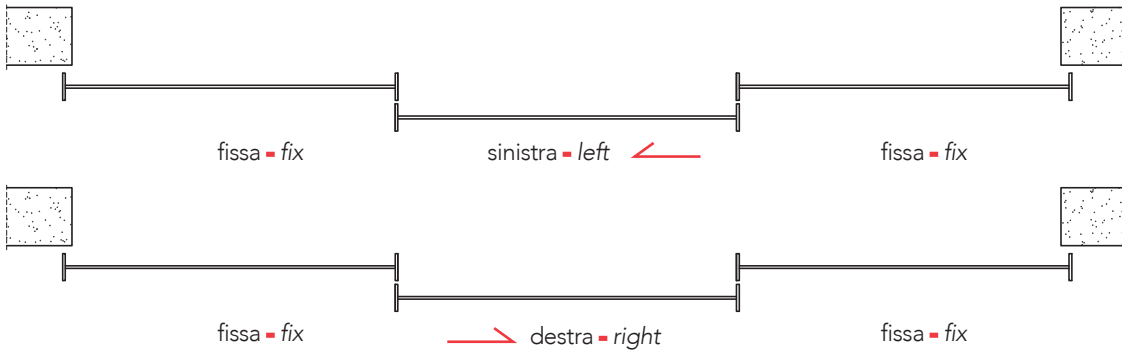

tre ante in luce  
three panels internal



quattro ante esterno muro  
four panels internal

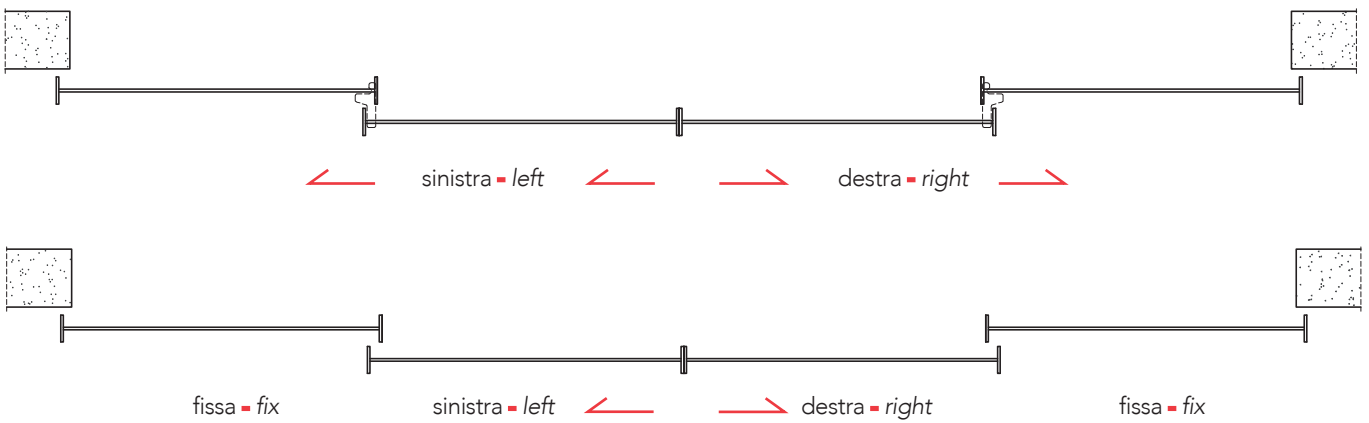

quattro ante interno muro  
four panels internal

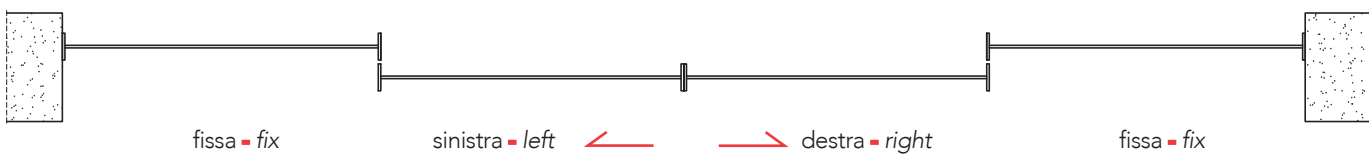

**Skye\_**

Dettagli in scala 1:1.  
Drawing details.

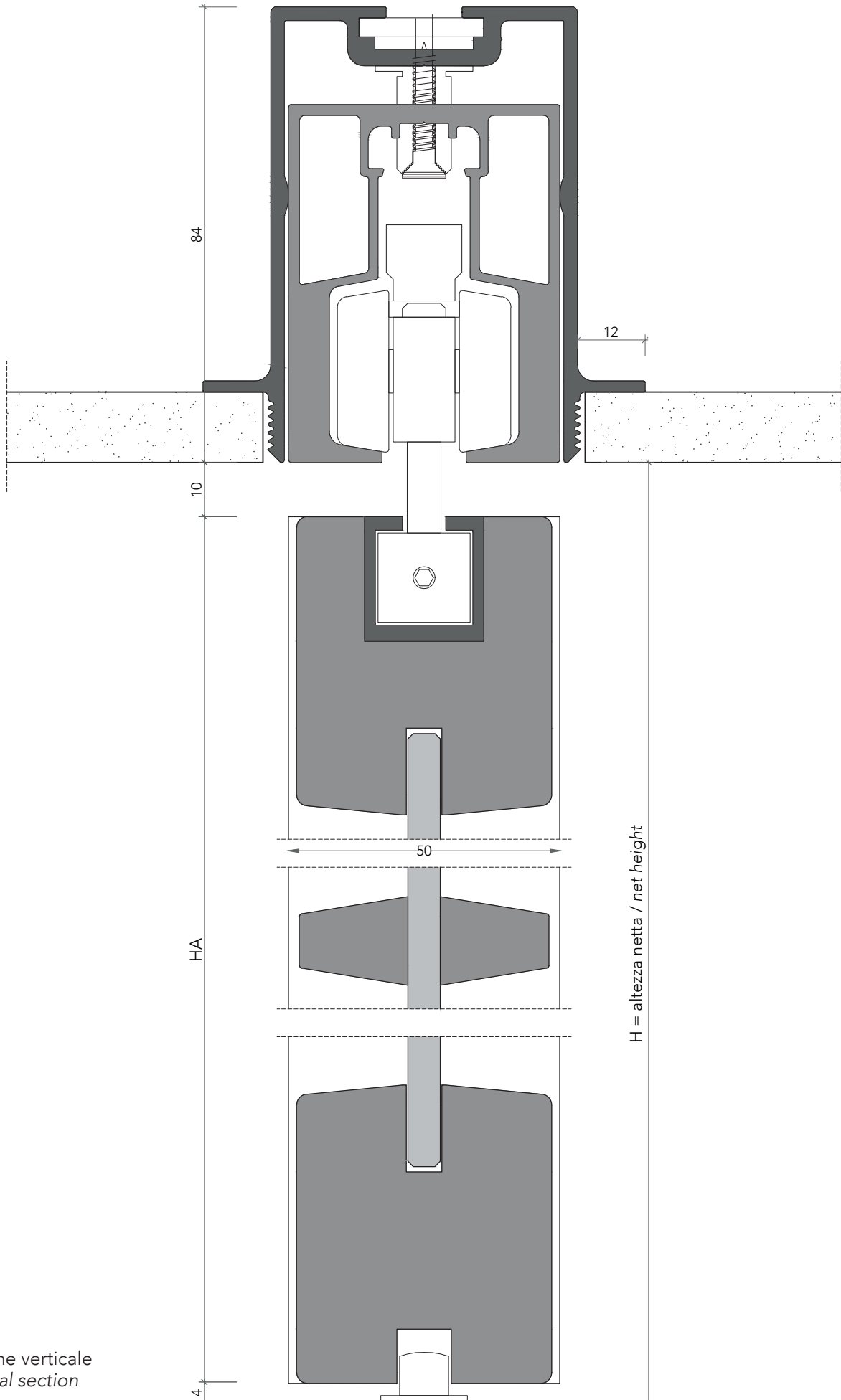

sezione verticale  
vertical section

H = altezza netta / net height

