

Shoin_

Sistema di ante scorrevoli in vetro e alluminio.
Sliding glass door system.

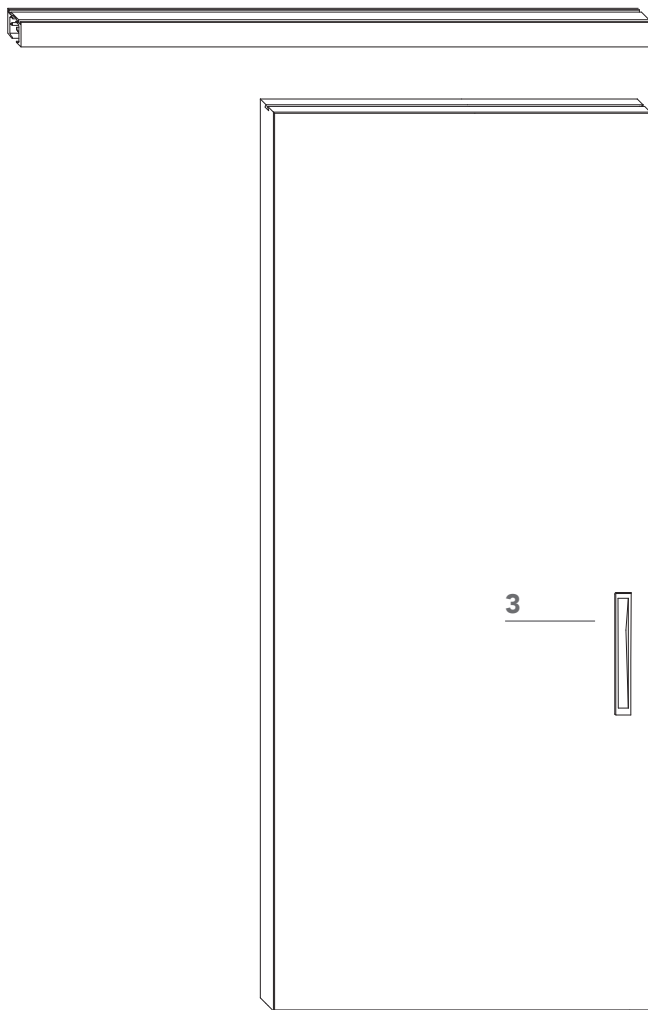

1 binario con sistema decelerante e carrello con meccanismo di regolazione in altezza;

rail with shock absorber system and trolley with height adjustment mechanism;

2 anta di spessore 50 mm, configurabile in diversi sistemi di pannelli scorrevoli e fissi, disponibile con vetro di sicurezza spessore 6 mm e profilo in alluminio;

sliding system with aluminum frame 50 mm thick, and tempered glass 6 mm thick. The system is available with fix and sliding panels;

3 maniglia inclusa.
handle included.

Finiture - Finishing

Binario e profilo anta - Rail and panel profile

alluminio - aluminum

naturale - nero opaco - bianco opaco - bronzo - brill spazzolato - natural - matte black - matte white - bronze - brushed brill

Anta in vetro - Glass panel

vetri base - standard glass

trasparente: extrachiaro - grigio - bronzo - transparent: extraclear - grey - bronze

satinato (un lato) : extrachiaro - grigio - bronzo - satin (one side): extraclear - grey - bronze

vetri riflettenti - reflective glass

riflettente (un lato) : extrachiaro - grigio - bronzo - reflective (one side): extraclear - grey - bronze

vetri speciali - special glass

trasparente flutes (lato A) : extrachiaro - grigio - transparent flutes (side A) : extraclear - grey

marks: extrachiaro - extrachiaro satinato (un lato) - marks: extraclear - extraclear satin (one side)

Shoin_
binario singolo / single rail

binario ad incasso - recessed rail

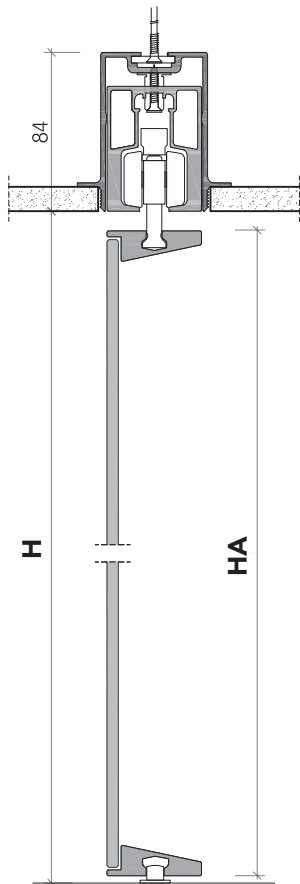

binario esterno - external rail

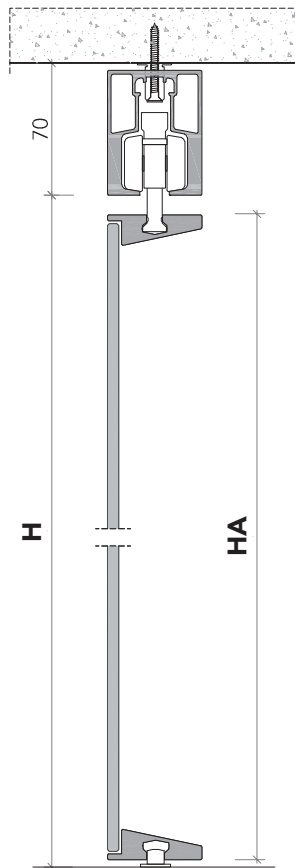

binario a parete - wall rail

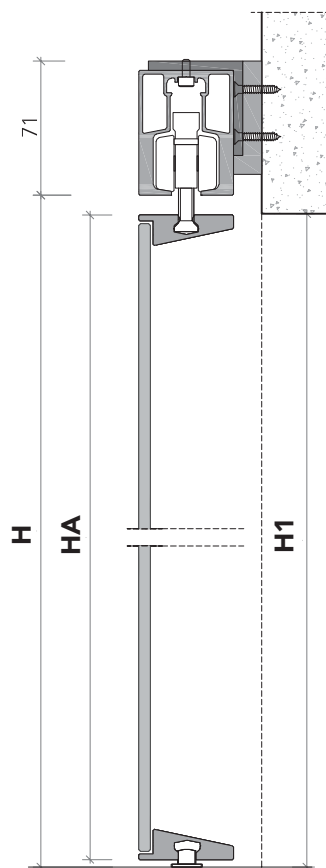

misure nette | **L** = luce / width
net opening | **H** = altezza / height

misura anta | **LA** = L + 14 mm
panel sizes | **HA** = H - 14 mm

H1 = H - 10 mm

falso binario
subframe

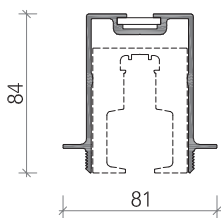

binario singolo
single rail

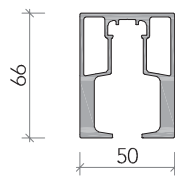

supporto a parete
wall fastening

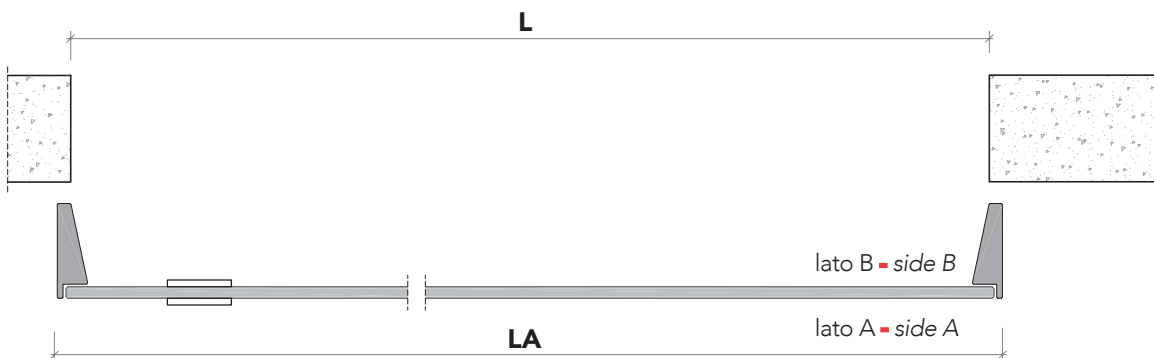
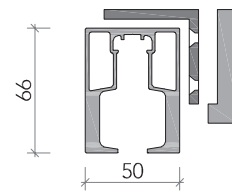

Shoin_
binario doppio / double rail

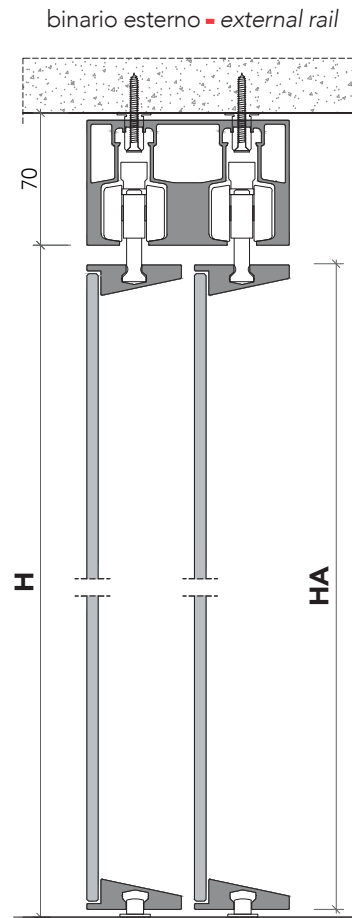
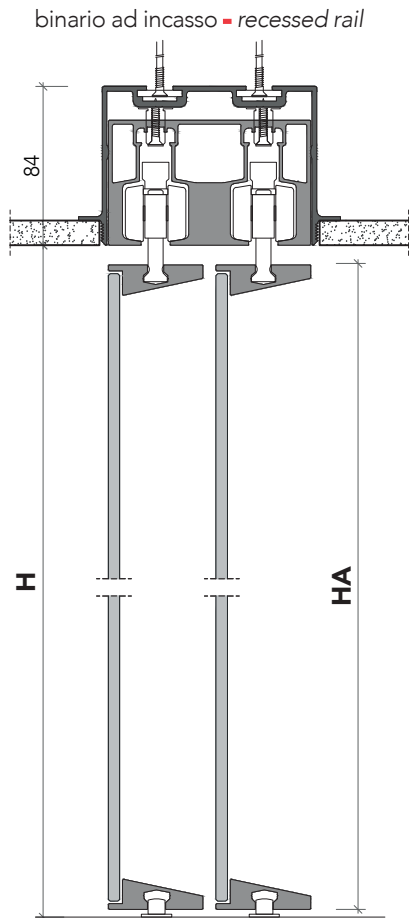

misure nette | **L** = luce / width
 net opening | **H** = altezza / height

misura anta | **LA** = $(L + 7 \text{ mm}) / 2$
 panel sizes | **HA** = $H - 14 \text{ mm}$

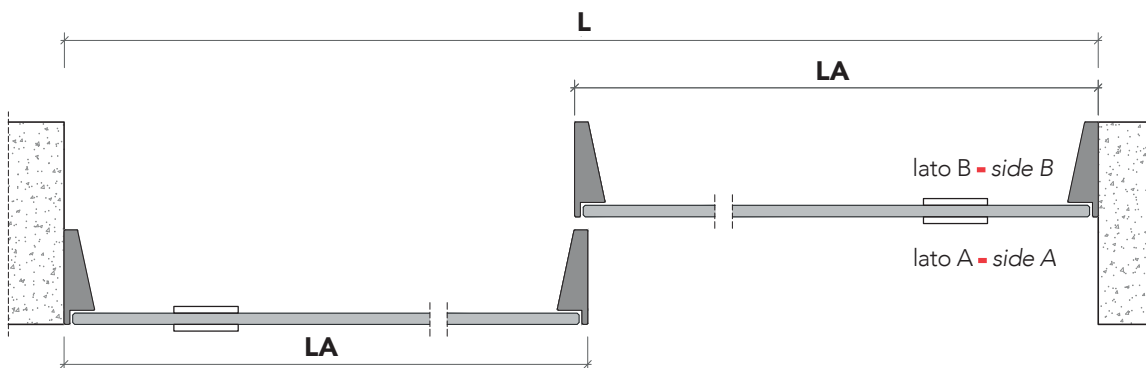
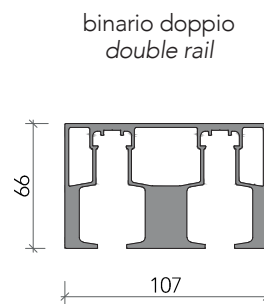
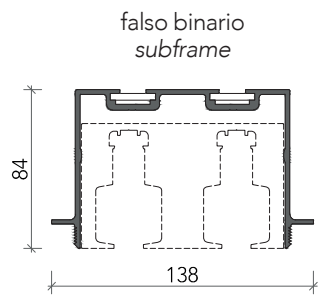

Sistemi scorrevoli / Sliding system

configurazioni / configuration

anta singola esterno muro
single panel external

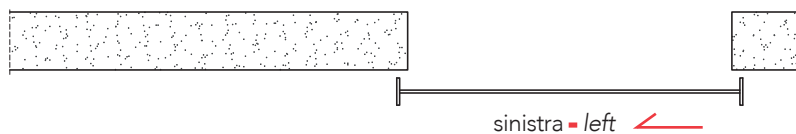
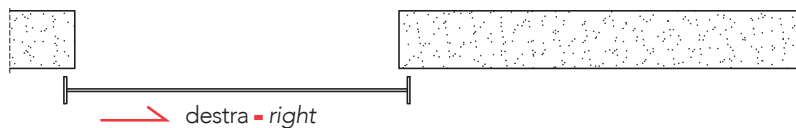

anta doppia esterno muro
double panel external

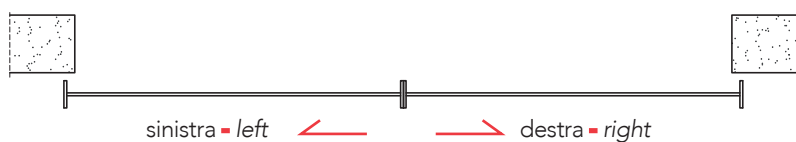

anta doppia in luce
double panel internal

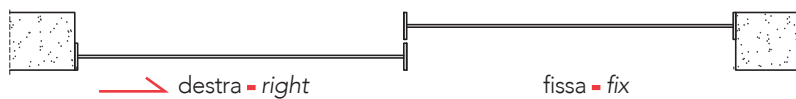
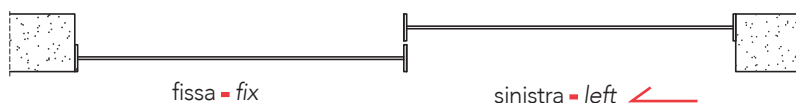

Sistemi scorrevoli / Sliding system

configurazioni / configuration

tre ante esterno muro
three panels external

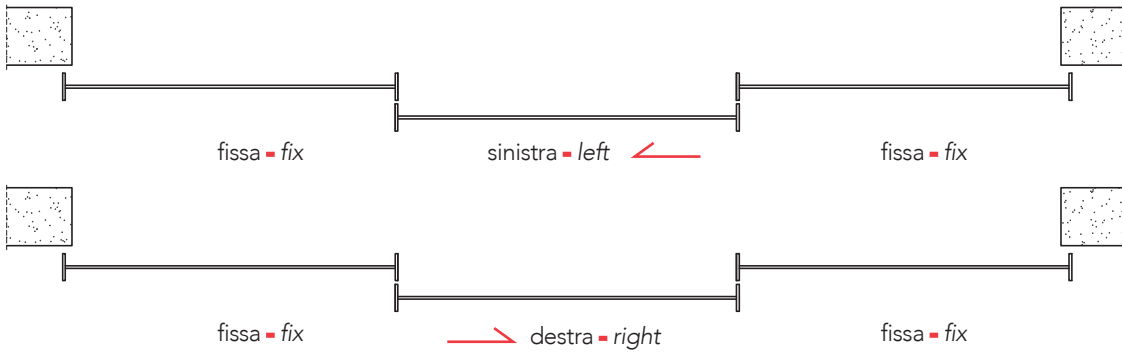

tre ante in luce
three panels internal



quattro ante esterno muro
four panels internal

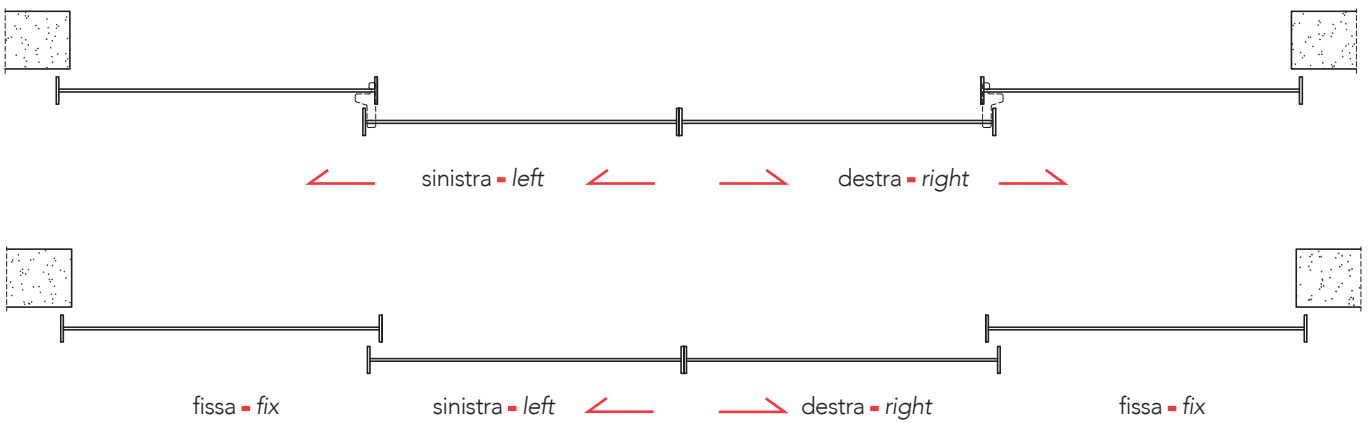

quattro ante interno muro
four panels internal

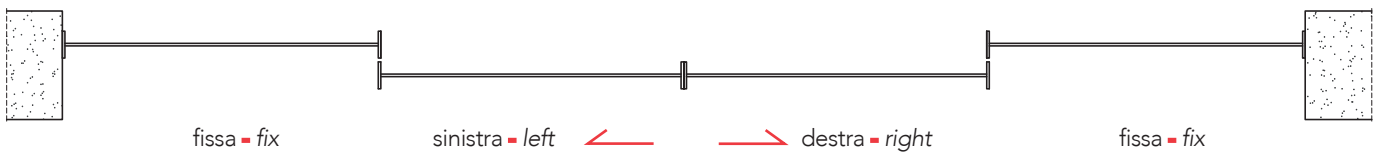

Shoin_

Dettagli in scala 1:1.
Drawing details.

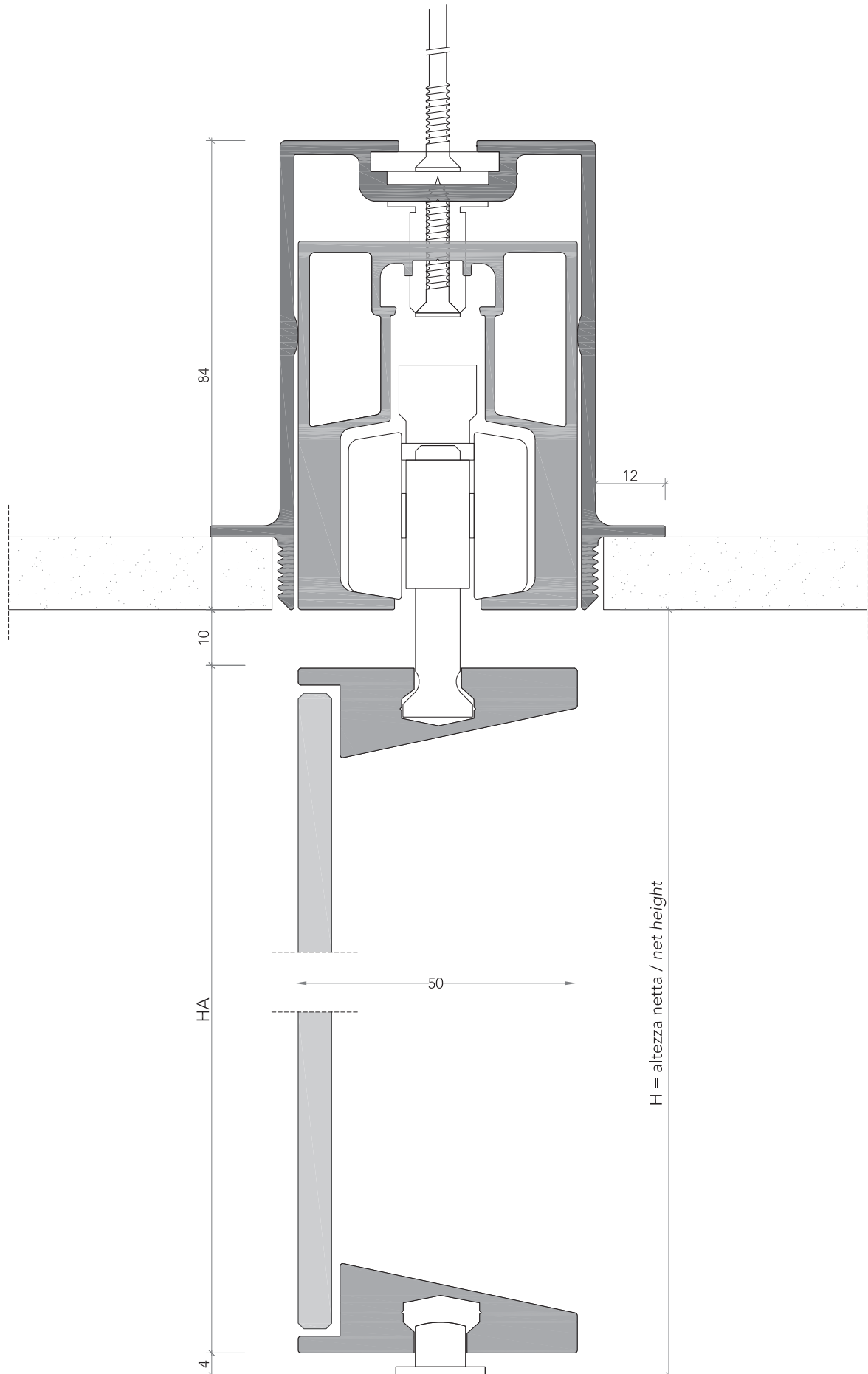

sezione verticale
vertical section

Shoin_

Dettagli in scala 1:1.
Drawing details.

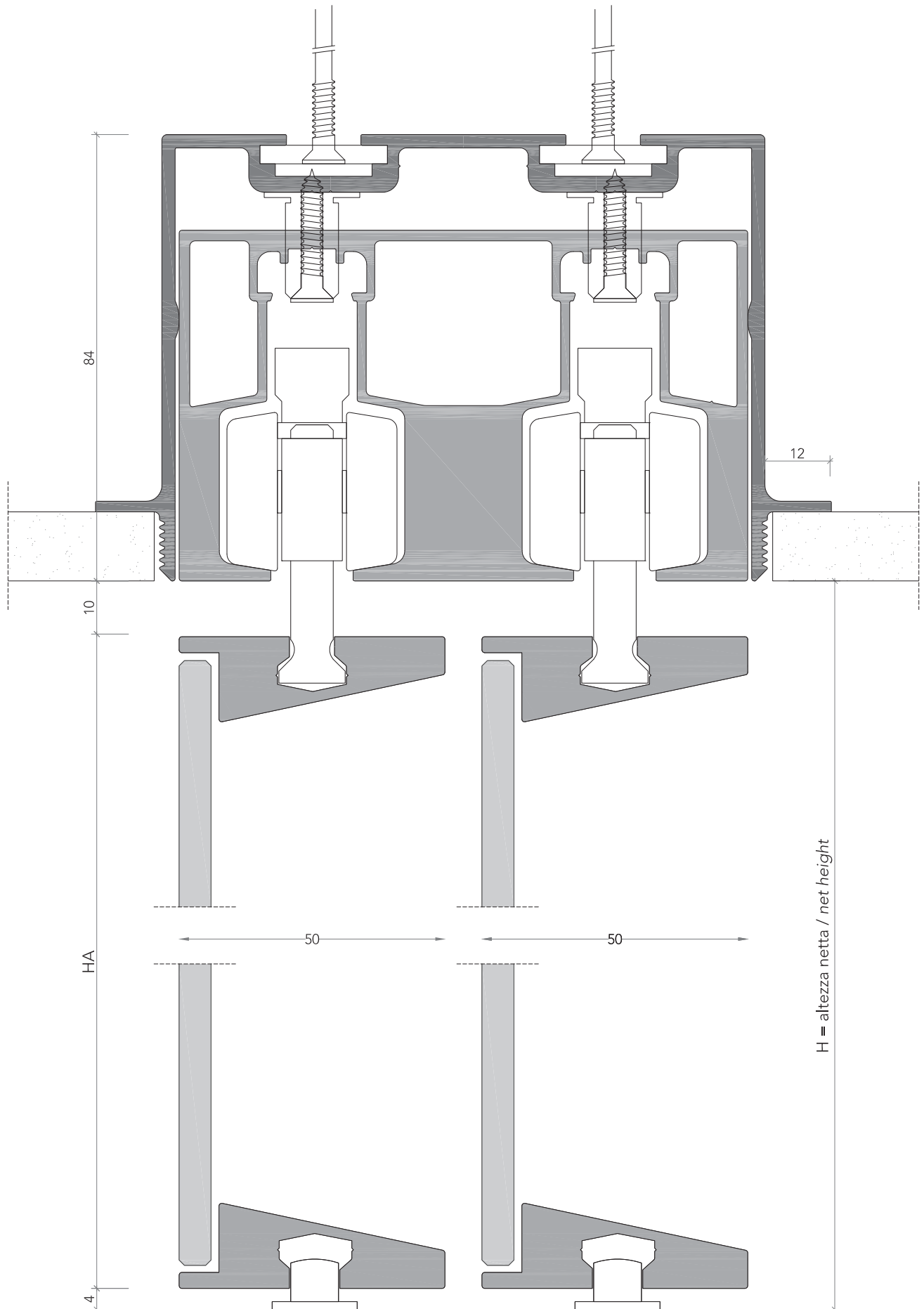

sezione verticale
vertical section