

## Shoin Pivot\_

Sistema di ante pivotanti e fisse in vetro e alluminio.  
*Pivoting glass door system.*

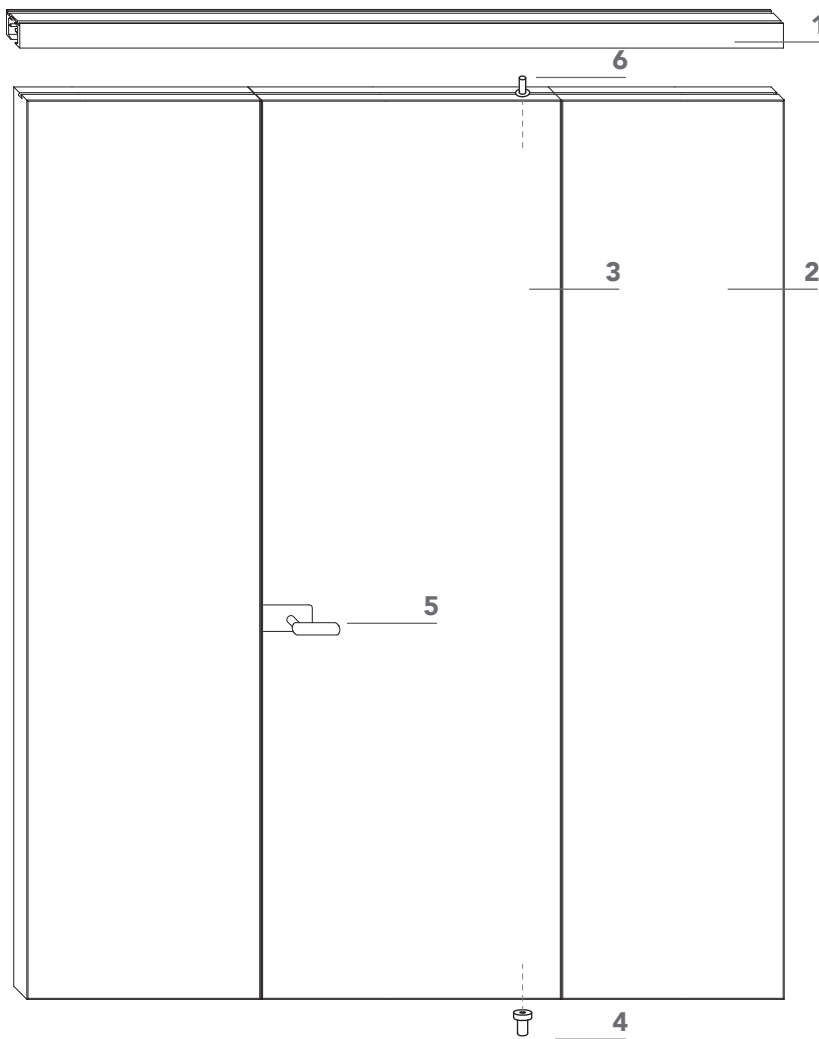

**1** binario a soffitto;  
*ceiling rail;*

**2** pannello fisso di spessore 50 mm;  
*50 mm thick fixed panel;*

**3** porta a bilico di spessore 50 mm, configurabile in diversi sistemi di pannelli pivotanti e fissi, disponibile con vetro di sicurezza spessore 6 mm e profilo in alluminio. Completa di serratura e perni di fissaggio (**4-6**);

*pivoting door with aluminum frame 50 mm, and tempered glass 6 mm thick. The system is available with fix and pivoting panels. Hardware included: lockset and locking pins (**4-6**);*

**4** perno di fissaggio a pavimento;  
*floor pin;*

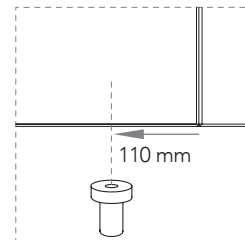

**5** maniglia Ishi.  
*Ishi handle.*

## Finiture - Finishing

### Binario e profilo anta - Rail and panel profile

alluminio - *aluminum*

naturale - nero opaco - bianco opaco - bronzo - brill spazzolato - *natural - matte black - matte white - bronze - brushed brill*

### Anta in vetro - Glass panel

vetri base - *standard glass*

trasparente: extrachiaro - grigio - bronzo - *transparent: extraclear - grey - bronze*

satinato (un lato) : extrachiaro - grigio - bronzo - *satin (one side): extraclear - grey - bronze*

vetri riflettenti - *reflective glass*

riflettente (un lato) : extrachiaro - grigio - bronzo - *reflective (one side): extraclear - grey - bronze*

vetri speciali - *special glass*

trasparente flutes (lato A) : extrachiaro - grigio - *transparent flutes (side A): extraclear - grey*

marks: extrachiaro - extrachiaro satinato (un lato) - *marks: extraclear - extraclear satin (one side)*

# Shoin Pivot\_

binario ad incasso ■ *concealed rail*

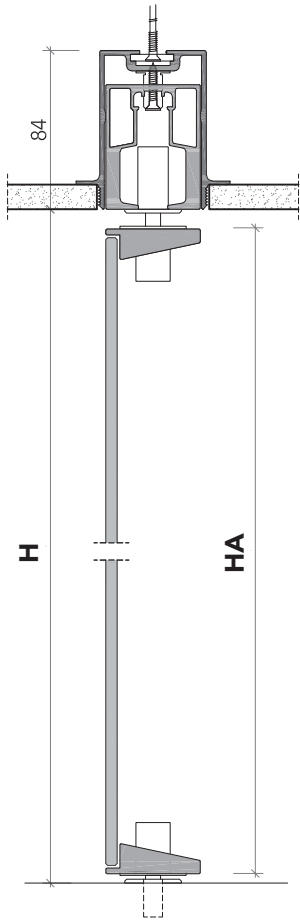

binario esterno ■ *external rail*

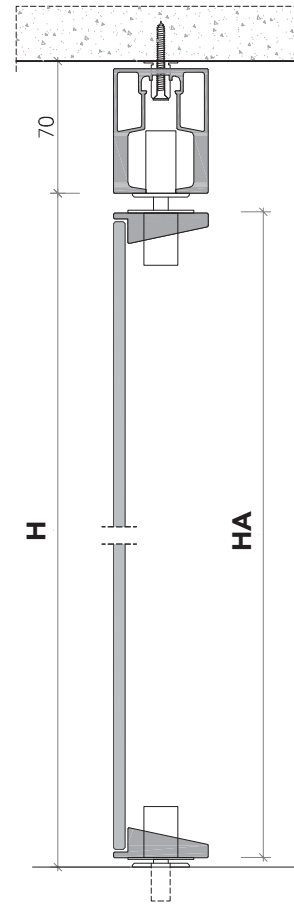

**H** = altezza / height

**HA** = H - 14 mm

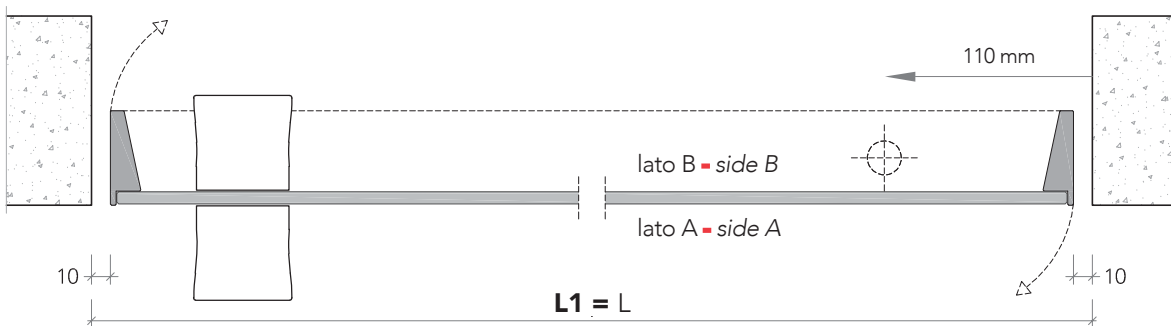
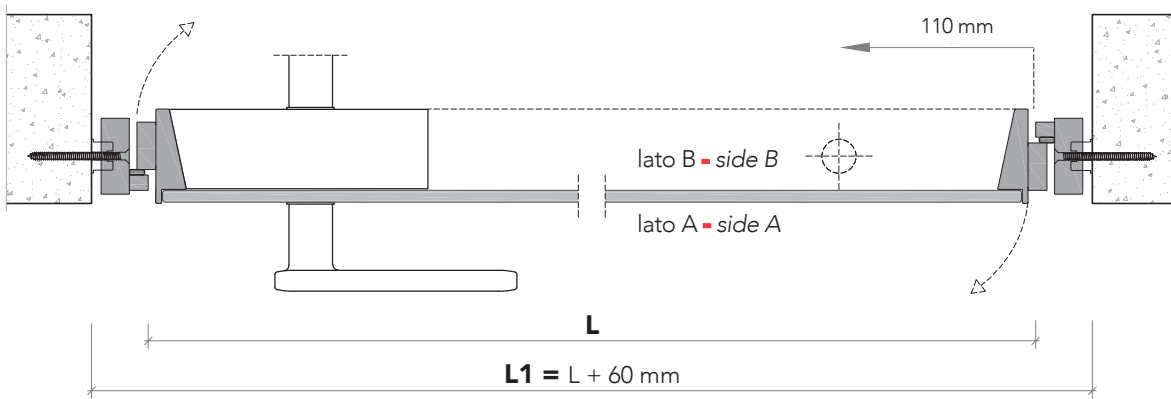

# Shoin Pivot\_

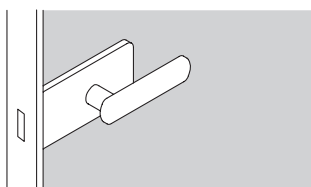
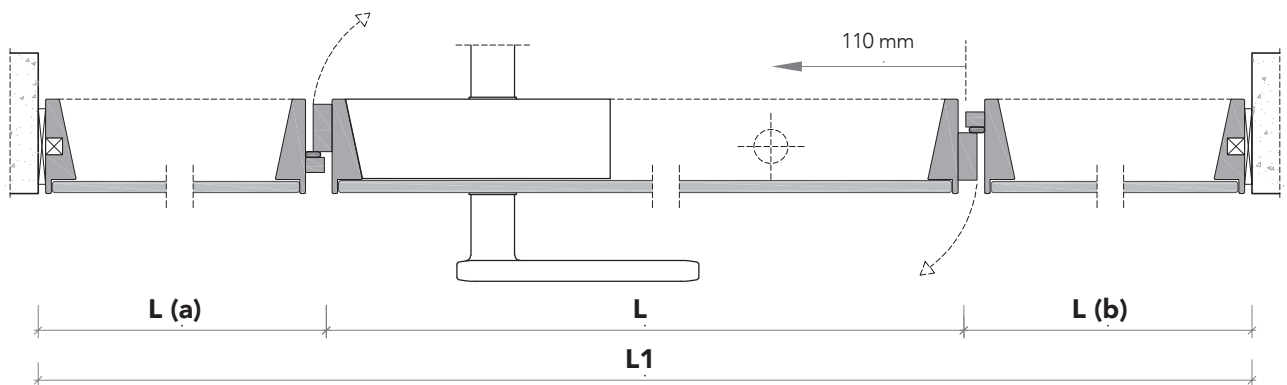
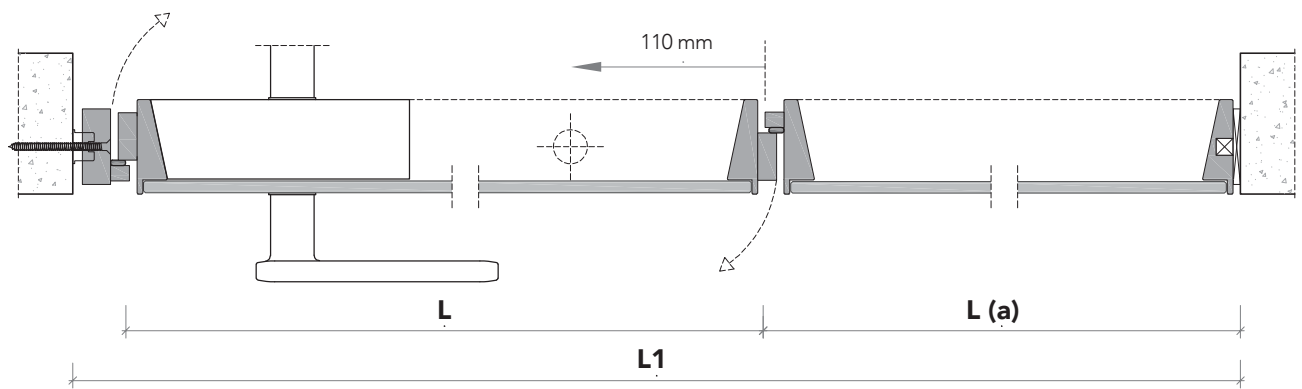

solo maniglia  
only passage

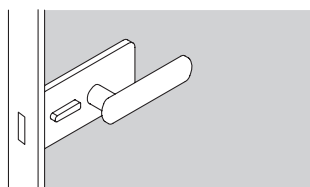

maniglia e nottolino  
handle and privacy

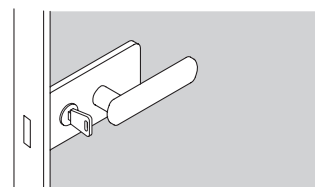

maniglia e cilindro di sicurezza  
handle and security cylinder

# Shoin Pivot\_

configurazioni / configuration

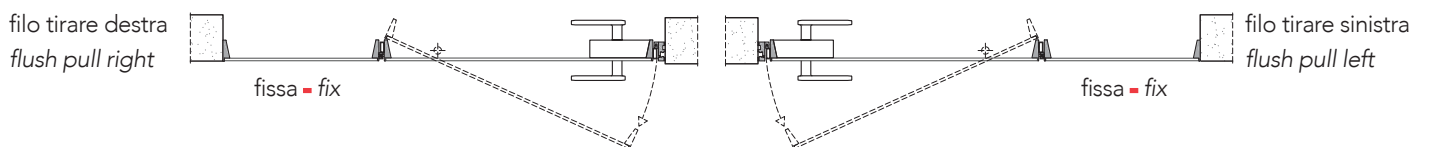
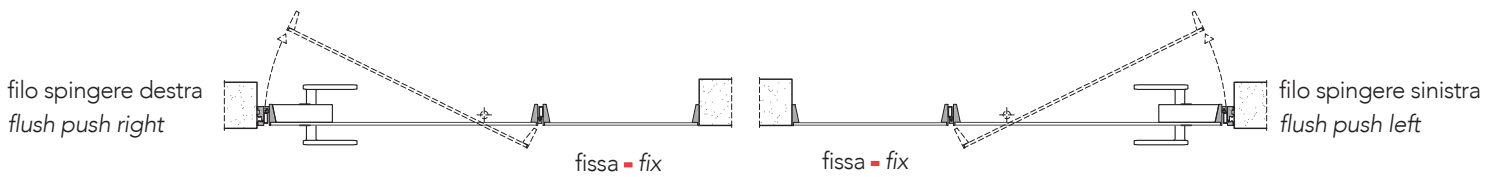
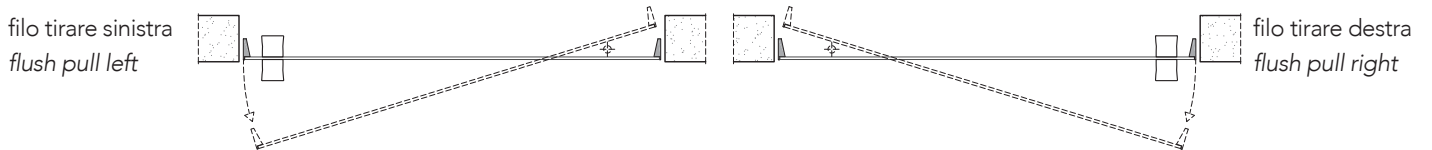
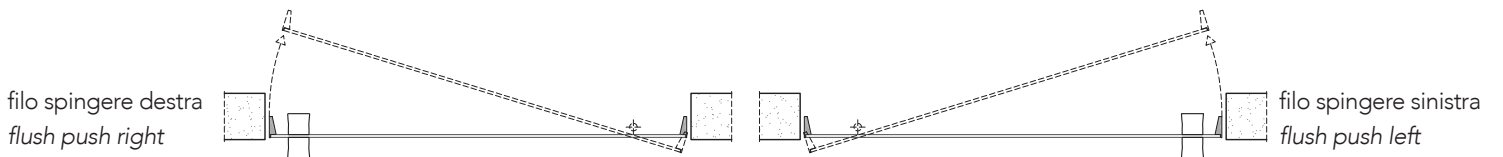
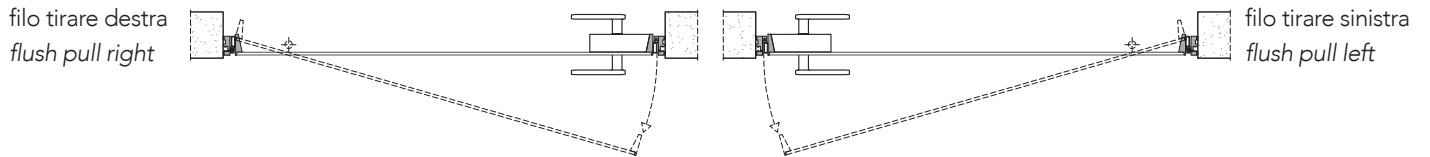
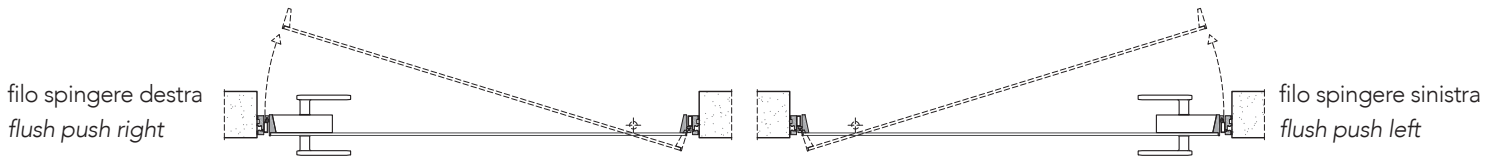

# Shoin Pivot\_

configurazioni / configuration

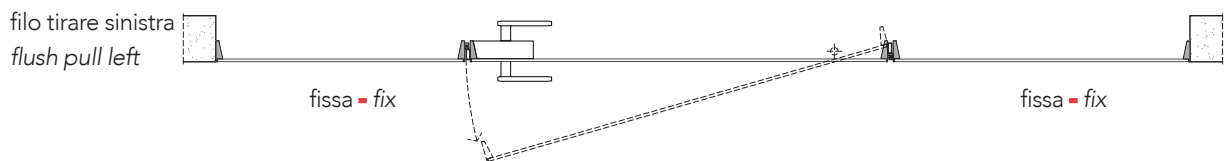
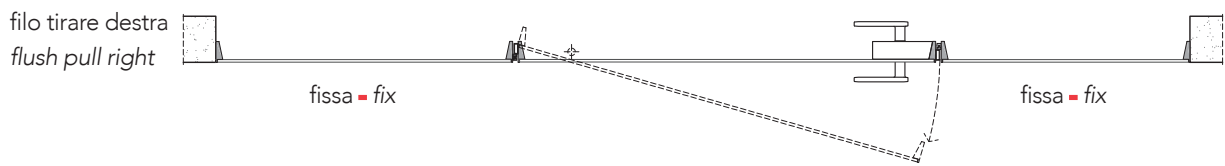
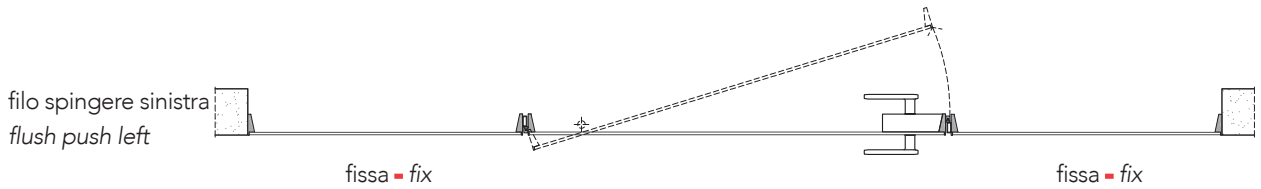
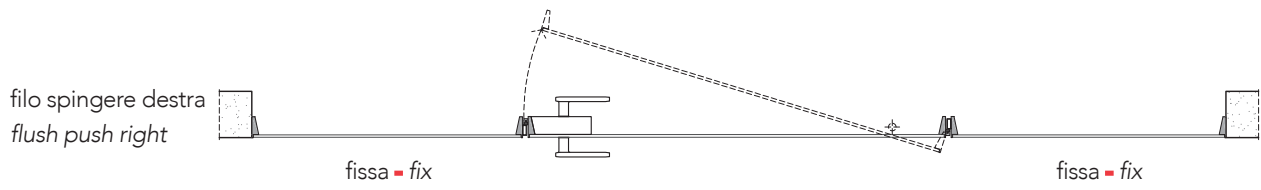
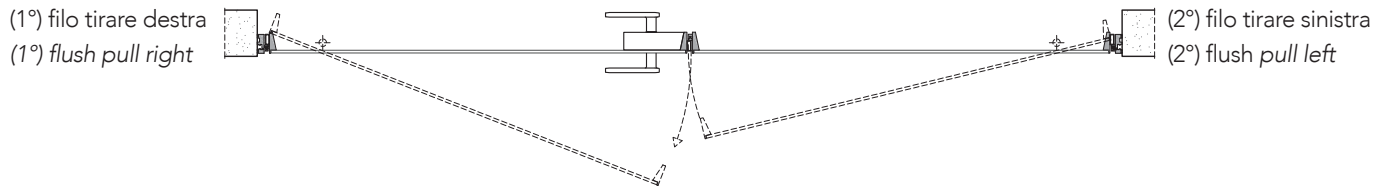
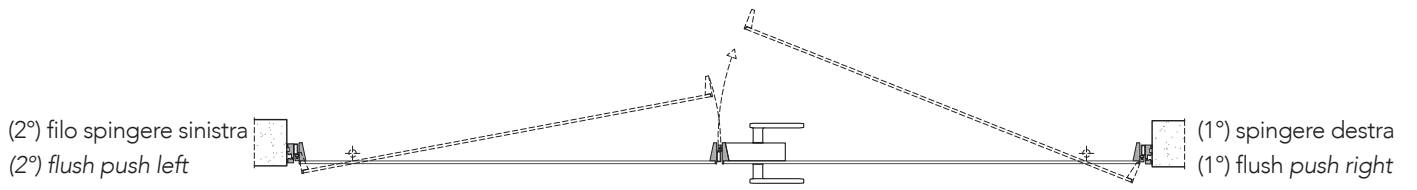

# Shoin\_ pivotante

Dettagli in scala 1:1.

Drawing details.

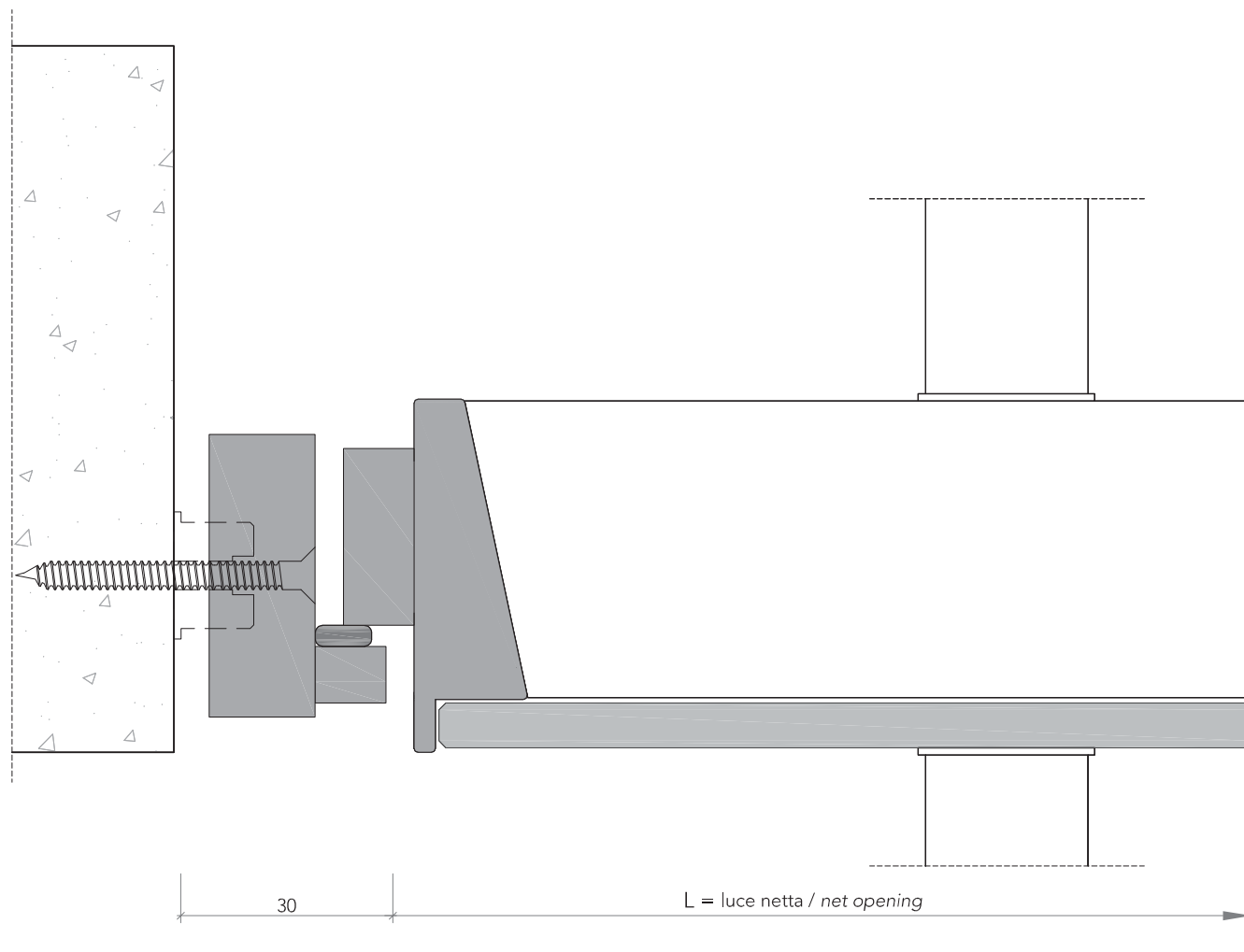

sezione orizzontale  
horizontal section

# Shoin\_pivotante

Dettagli in scala 1:1.

Drawing details.

