

L41_ scorrevole a scomparsa / pocket door

Porta con anta in legno o vetro e stipite in alluminio per controtelaio tipo Scrigno® Essential o Eclisse® Syntesis Line.
Sliding glass or wood pocket door system with aluminum frame.

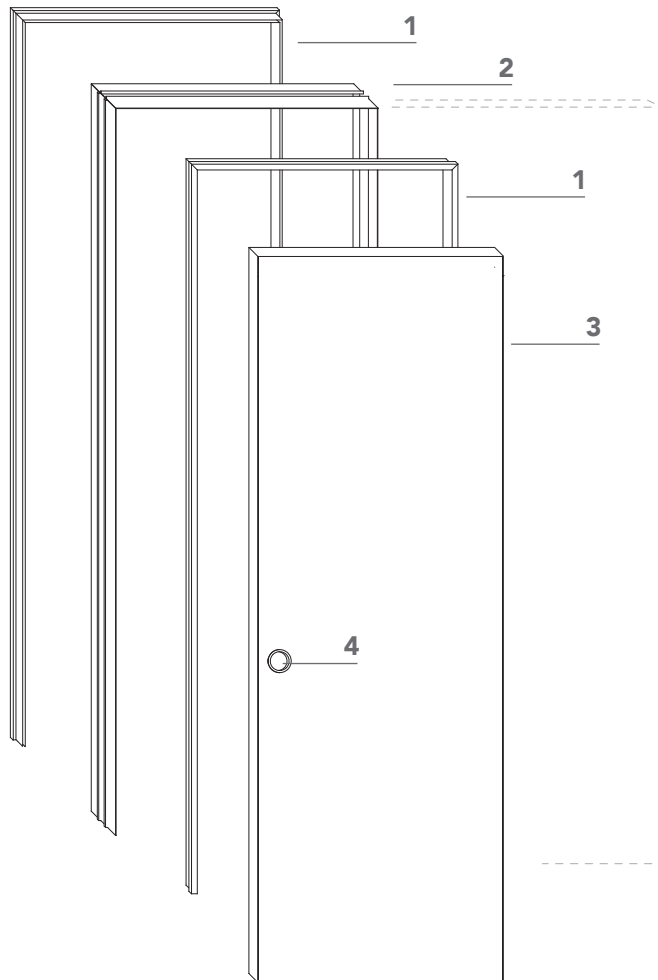

- 1** coprifilo telescopico in alluminio, di serie per misure da 105 mm a 125 mm;
telescopic aluminum trim for wall thickness from 105 up to 125 mm;
- 2** stipite in alluminio;
aluminum door frame;
- 3** anta di spessore 41 mm in vetro, con telaio in alluminio, oppure in legno. Completa di ferramenta e maniglia (**4**);
*glass sliding pocket door, with aluminium frame, or wood sliding pocket door, 41 mm thickness. Hardware and flush handle included (**4**);*
- 4** maniglia ad incasso.
flush handle.

Finiture - Finishing

Stipite e profilo anta - Frame and panel profile

alluminio - aluminum

naturale - nero opaco - bianco opaco - bronzo - brill spazzolato - *natural - matte black - matte white - bronze - brushed brill*

Anta in legno - Wood panel

laccati opachi e lucidi - *matte and glossy lacquer paint*

bianco gesso - bianco ottico - avorio - grigio calce - grigio tortora - grigio ferro - terra
chalk white - pure white - ivory - lime grey - dove grey - iron grey - clay

essenze - veneer

rovere : naturale - moka - thermowood - nero fossile - grigio - oak: *natural - moka - thermowood - black fossil - grey*
noce canaletto - *canaletto walnut*

Anta in vetro - Glass panel

vetri base - *standard glass*

trasparente: grigio - bronzo - *transparent: grey - bronze*

satinato (un lato) : extrachiaro - grigio - bronzo - *satin (one side): extraclear - grey - bronze*

vetri riflettenti - *reflective glass*

riflettente (un lato) : grigio - bronzo - *reflective (one side): grey - bronze*

vetri retrolaccati - *backpainted glass*

bianco gesso - bianco ottico - avorio - grigio calce - grigio tortora - grigio ferro - terra
chalk white - pure white - ivory - lime grey - dove grey - iron grey - clay

L41_ scorrevole a scomparsa / pocket door

sezione verticale - vertical section

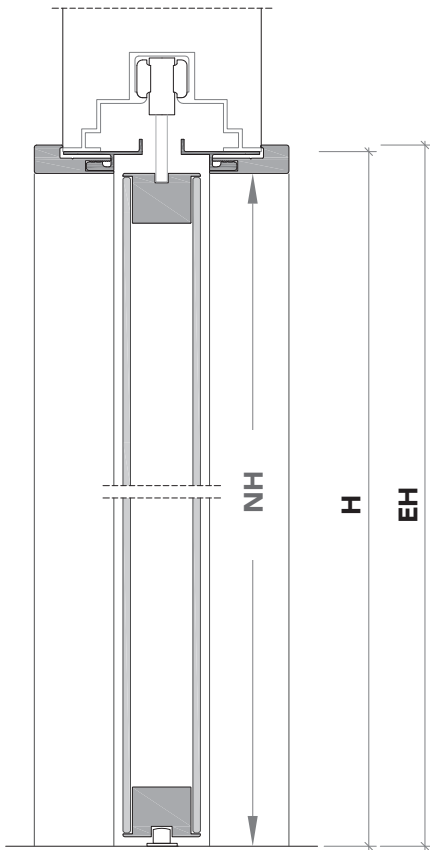

misure controtelaio
 pocket opening

- L** = luce / width
- H** = altezza / height
- PF** = parete finita / wall thickness
- SI** = sede interna / internal space

misure effettive
 clear opening

- NL** = L - 23 mm
- NH** = H - 12 mm

ingombro totale
 overall sizes

- EL** = NL + 30 mm
- EH** = NH + 15 mm

sezione orizzontale - horizontal section

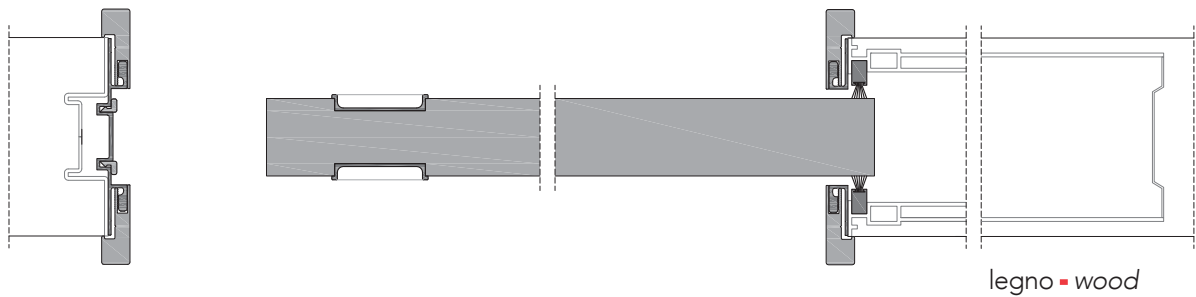
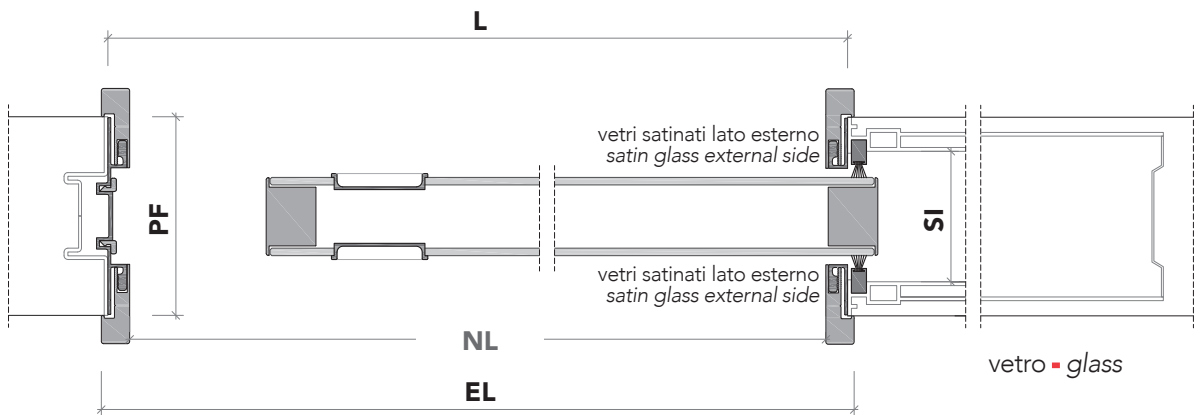

L41_ scorrevole a scomparsa / pocket door

parete con rivestimento - cladding wall version

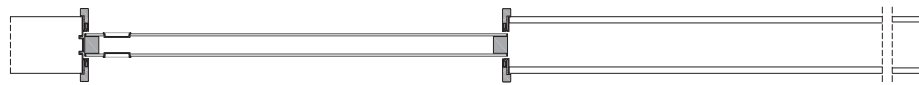
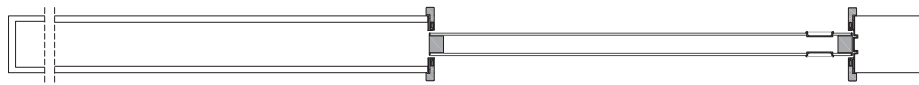
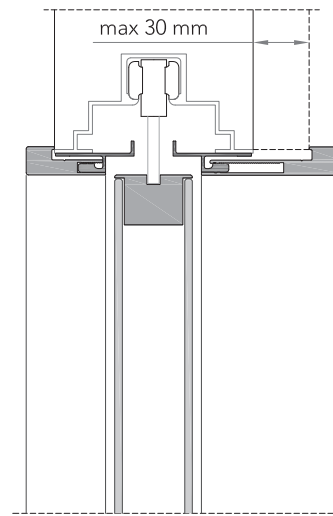
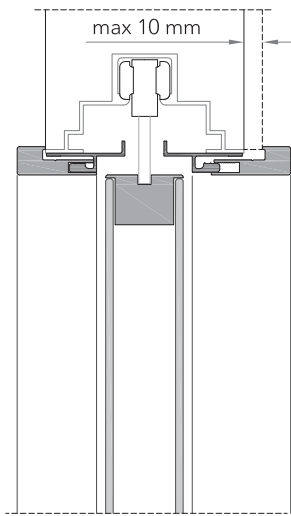

vetro - glass

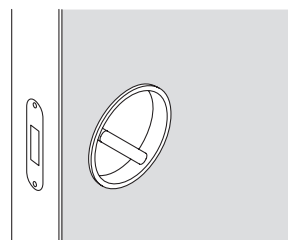
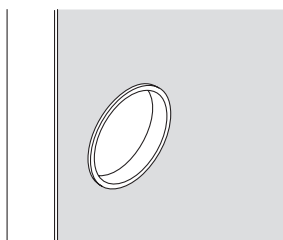

legno - wood

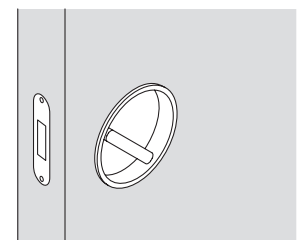
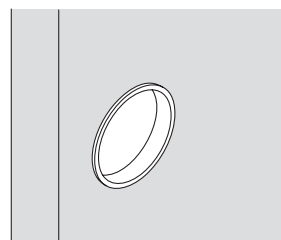

L41_ scorrevole a scomparsa / pocket door

Dettagli in scala 1:1.

Drawing details.

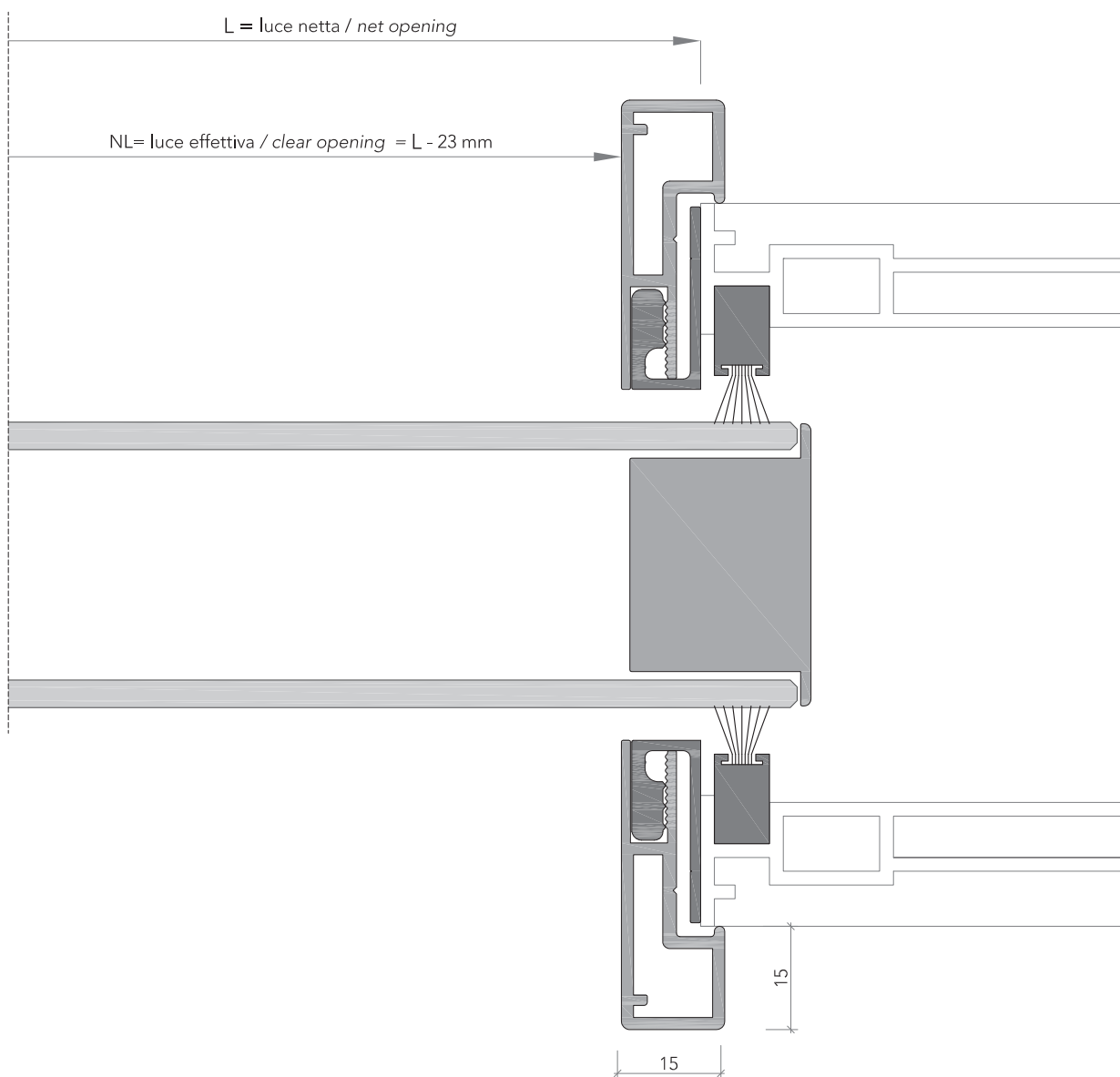

sezione orizzontale
horizontal section

L41_ scorrevole a scomparsa / pocket door

Dettagli in scala 1:1.

Drawing details.

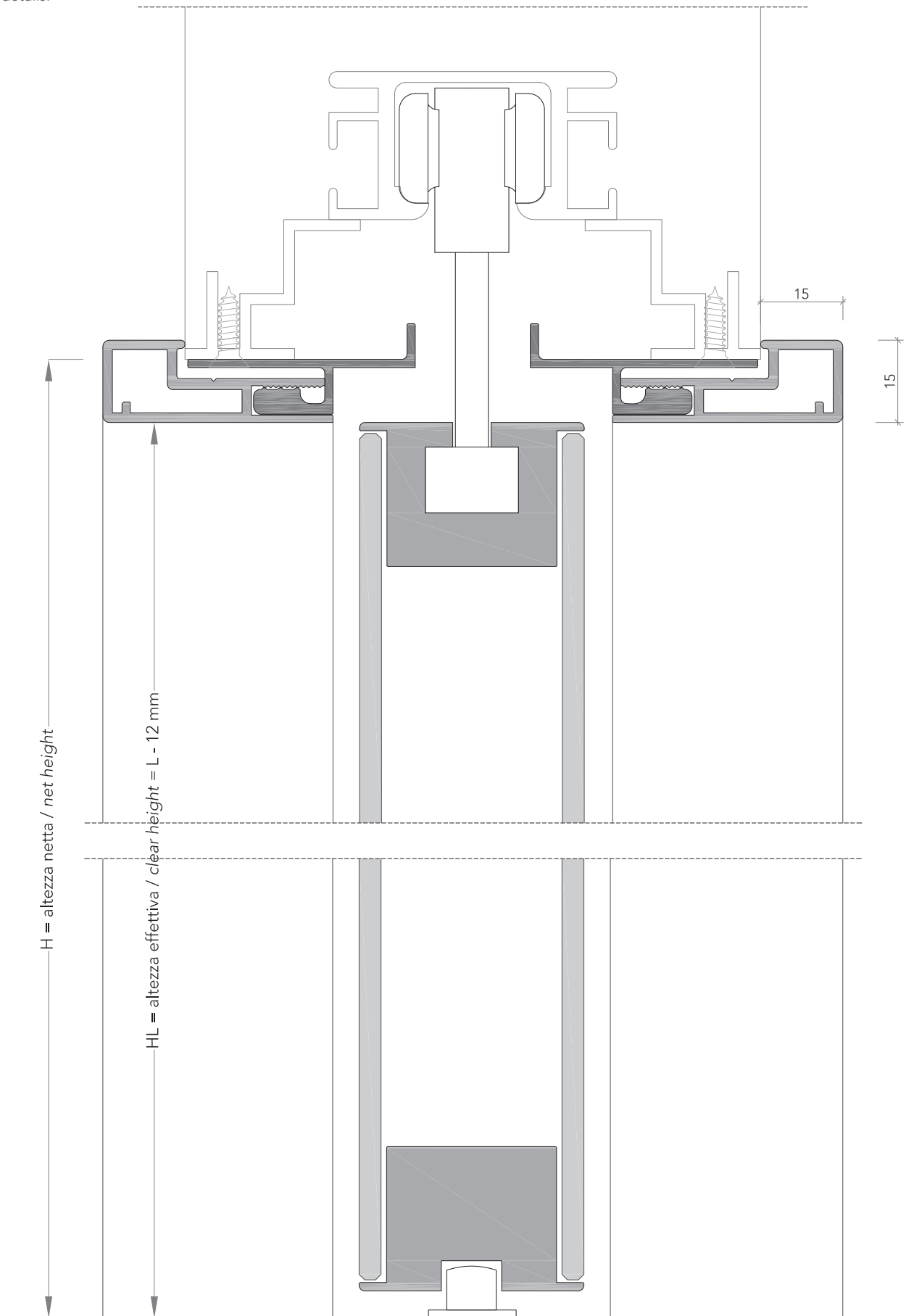

sezione verticale
vertical section