

Shoin_pivotante

Sistema di ante pivotanti e fisse in vetro e alluminio.
Pivoting glass door system.

Shoin_pivotante

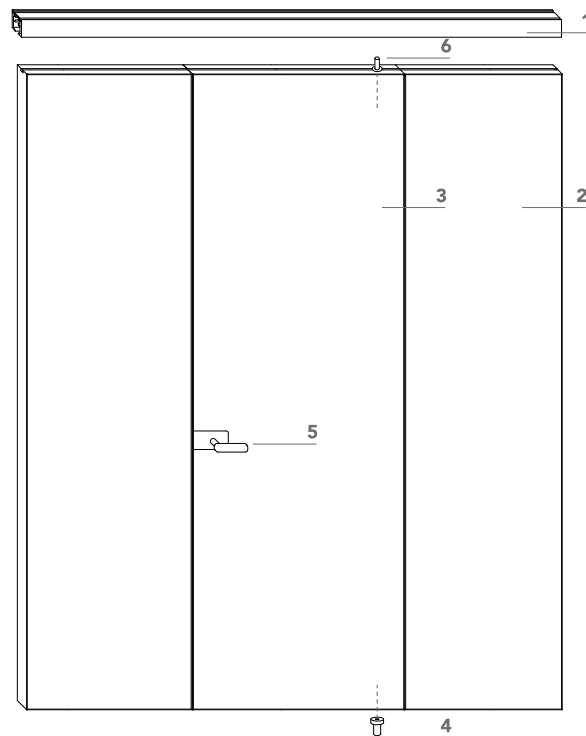

- 1 binario a soffitto;
ceiling rail;
- 2 pannello fisso di spessore 50 mm;
50 mm thick fixed panel;
- 3 porta a bilico di spessore 50 mm,
configurabile in diversi sistemi di
pannelli pivotanti e fissi, disponibile
con vetro di sicurezza spessore 6 mm
e profilo in alluminio. Completa di
serratura e perni di fissaggio (4-6);

*pivoting door with aluminum frame 50
mm, and tempered glass 6 mm thick.
The system is available with fix and
pivoting panels. Hardware included:
lockset and locking pins (4-6);*

- 4 perno di fissaggio a pavimento;
floor pin;

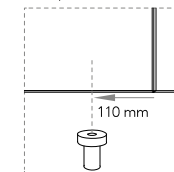

- 5 maniglia Ishi.
Ishi handle.

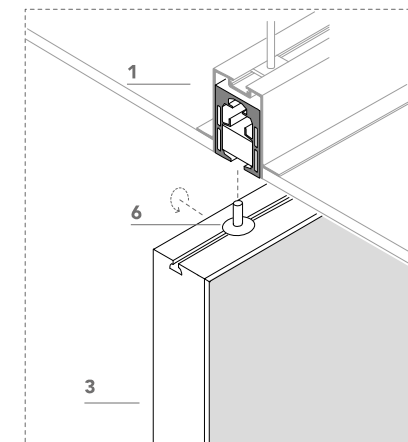
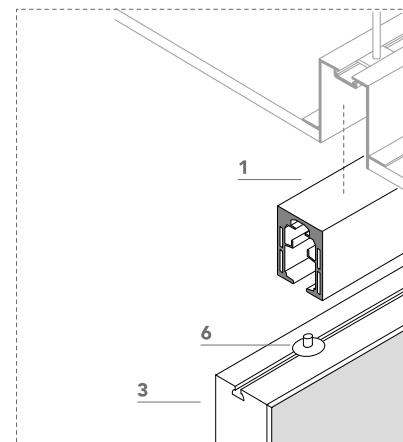

Shoin_pivotante

binario ad incasso = concealed rail

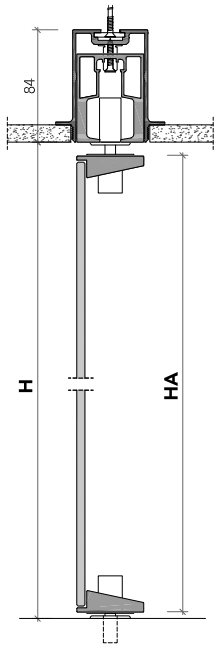

binario esterno = external rail

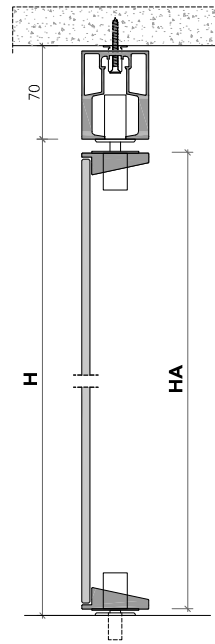

H = altezza / height
HA = H - 14 mm

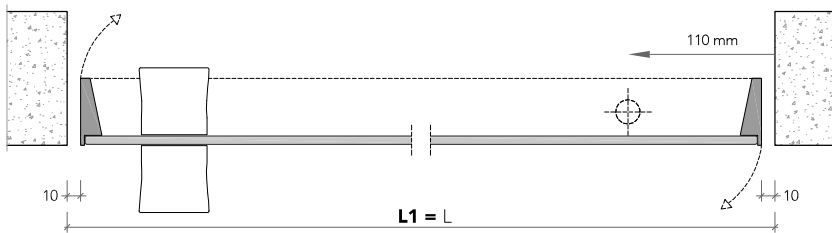
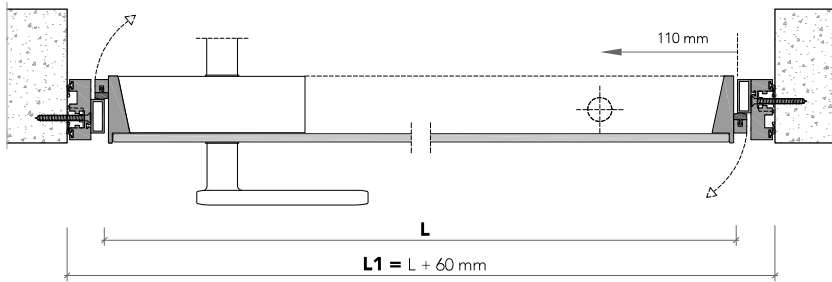

Shoin_pivotante

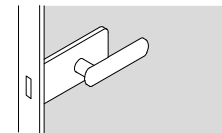
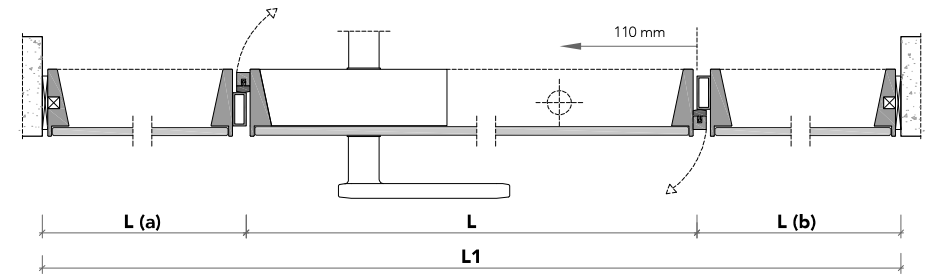
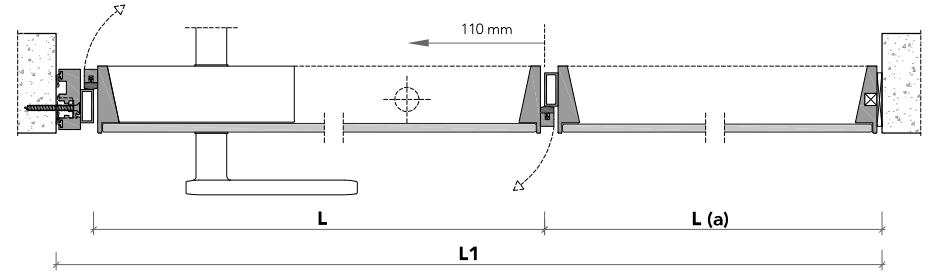

solo maniglia
only passage

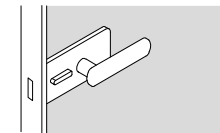

maniglia e nottolino
handle and privacy

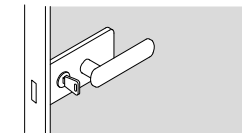

maniglia e cilindro di sicurezza
handle and security cylinder

anta singola a spingere
 single panel flush with push side

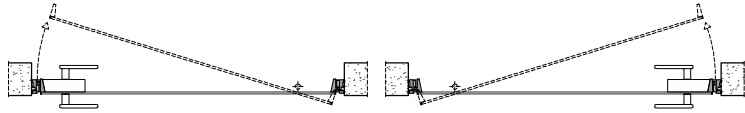

anta singola a tirare
 single panel flush with pull side

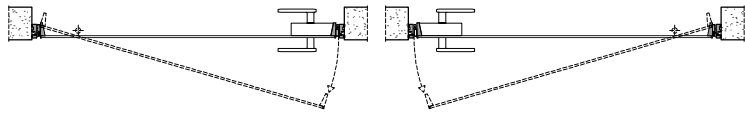

anta singola a spingere
 single panel flush with push side

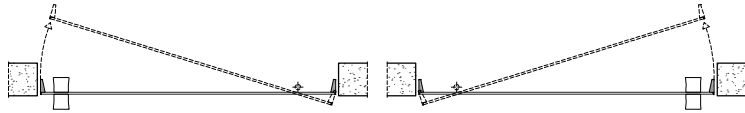

anta singola a tirare
 single panel flush with pull side

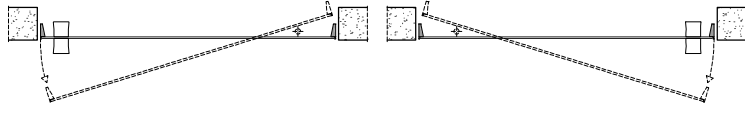

anta doppia a spingere
 double panel flush with push side

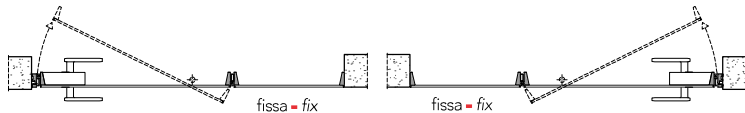

anta doppia a tirare
 double panel flush with pull side

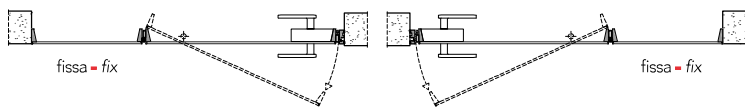

anta doppia a spingere
 double panel flush with push side

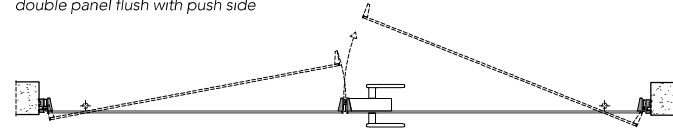

anta doppia a tirare
 double panel flush with pull side

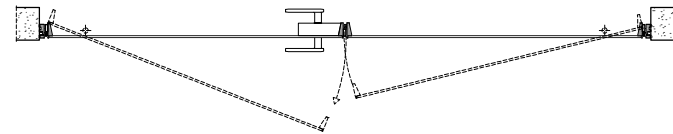

tre ante a spingere
 three panels flush with push side

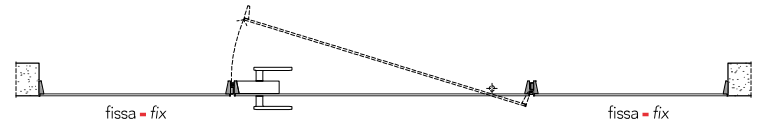

tre ante a tirare
 three panels flush with pull side



tre ante a tirare
 three panels flush with pull side

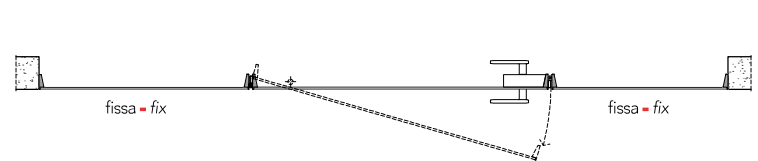

tre ante a tirare
 three panels flush with pull side

